

Transrectal Probe

EUP-R54AW-19

EUP-R54AW-33

INSTRUCTION MANUAL

Notes for operators and responsible maintenance personnel

- ★ Please read through this Instruction Manual carefully prior to use.
- ★ Keep this Instruction Manual together with the system with care to make it available anytime.

 **Hitachi, Ltd.**

Tokyo, Japan

Q1E-EP0609-11

© Hitachi, Ltd. 2013, 2017. All rights reserved.

Manufacturer:



Hitachi,Ltd.
2-16-1, Higashi-Ueno,taito-ku, Tokyo,110-0015,Japan
+81-3-6284-3668
<http://www.hitachi.com/businesses/healthcare/index.html>

European
Representative:



Hitachi Medical Systems GmbH
Otto-von-Guericke-Ring 3 D-65205 Wiesbaden, Germany

EU Importer:
Address:

Hitachi Medical Systems Europe Holding AG
Sumpfstrasse 13 CH-6300 Zug, Switzerland

Local Distributor:

About this manual

This instruction manual shall provide instructions for using, cleaning, disinfecting and/or sterilizing the HITACHI ultrasound probes. It also describes safety considerations, maintenance. For instructions for operating the main unit, refer to the operation manual for it.

Before using the probe, thoroughly read this manual and keep this book for future reference.

If you have any questions concerning the manual, please contact your HITACHI distributor.

The following conventions are used throughout the manual to denote information of special emphasis.



WARNING: "Warning" is used to indicate the presence of a hazard which can cause severe personal injury, death, or substantial property damage if the warning is ignored.

CAUTION: "Caution" is used to indicate the presence of a hazard which will or can cause minor personal injury or property damage if the caution is ignored.

NOTICE: "Notice" is used to notify people of installation, operation, or maintenance information which is important, but not hazard related.









Graphical Symbols for Use in Labeling of Hitachi Ultrasound Probes

Some graphical symbols that are used in labeling of Hitachi Ultrasound Probes are compliant with EN980:2008 standard. Refer to the following table about the meanings of them.

Explanation of Symbol	Symbol	Descriptive Content
Manufacturer Company Name and Address		Hitachi,Ltd 2-16-1,Higashi-Ueno,taito-ku, Tokyo,110-0015,Japan +81-3-6284-3668 http://www.hitachi.com/businesses/healthcare/index.html
Authorized Representative in The European Community		Hitachi Medical Systems GmbH Otto-von-Guericke-Ring 3 D-65205 Wiesbaden, Germany
Keep away from Sunlight		Store the probe in a cool place and keep away from high temperature, high humidity, or direct sunlight.

Definition of symbol

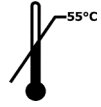
The following symbol is also used for HITACHI Ultrasound Probes.

Location	Symbol	Definition
Probe connector		This instrument complies with Directive 93/42/EEC relating to Medical Device and Directive 2011/65/EU relating to RoHS
Probe connector	IPX7	IPX7 mark See section 1.6.
Probe connector		Type BF APPLIED PART
Probe connector		General warning sign
Probe connector		Warning; dangerous voltage
Probe connector		Caution; Biohazard
Probe connector		Follow the instruction manual to operate this instrument. If not avoided, may result in injury, property damage, or the equipment trouble.
Probe connector		STERRAD sterilization compatibility mark
Probe connector		Upper Limit of Temperature; The probes that are applicable to Ethylene Oxide Gas Sterilization use symbol of "Upper Limit of Temperature: 55 degrees".
Probe connector		Do not waste the instrument as general waste. Comply with a local regulation.
Probe connector	Rx Only	By prescription only. U.S. Federal Law restricts this device to sale on order of a physician only.

CONTENTS

Page

1. Introduction	1
1.1. Features	1
1.2. Principles of operation	1
1.3. Intended Use	1
1.4. Composition	1
1.5. Accessories	2
1.5.1. Probe cover	2
1.5.2. Waterproof box EZU-WB1 (Option)	2
1.6. Construction	2
2. Inspection before Use	3
2.1. Inspection for Appropriate Connection	3
2.2. Inspection for Material Surface	3
3. Operation Procedure	4
3.1. Connection and Settings of Main Unit	4
3.2. General instruction	5
3.2.1. Preparation before starting diagnosis	5
3.2.2. Insertion of the probe into body	6
3.2.3. How to remove the protective sheaths	6
3.2.4. After use of the probe	6
4. Cleaning, Disinfection and Sterilization	7
4.1. Point of use (Pre-cleaning)	8
4.2. Containment and transportation	9
4.3. Manual Cleaning and disinfection	9
4.4. Automated cleaning and disinfection	11
4.5. Drying	12
4.6. Inspection	12
4.7. Packaging	13
4.8. Sterilization	14
4.9. Storage	15
5. Safety Precautions	16
6. Specifications	17
6.1. EUP-R54AW-19	17
6.2. EUP-R54AW-33	18
6.3. Suppliers List	19
6.4. Transducer covers	20
7. Disposal of the probe	21

1. Introduction

1.1. Features

The probe models EUP-R54AW-19 and EUP-R54AW-33 are convex array electronic scanning type probes.

The acoustic output of these probes when connected to the ultrasound scanner was measured according to the IEC60601-2-37 standard. The table of measured acoustic output data is contained in the operation manual of each ultrasound scanner.

These probes are categorized in class IIa according to Directive 93/42/EEC.

According to IEC 60601-1 the probes are classified as type BF.

1.2. Principles of operation

These probes and the ultrasound diagnostic scanner enable image diagnosis using ultrasonic waves. This system operates under the principles described below.

- 1) When an electric pulse signal is applied from the transmitter to the transducer of the probe, the transducer converts electric signals into mechanical vibration energy for emitting pulse-shaped ultrasonic waves into the body part, liquid or other medium contacting the transducer.
- 2) The emitted ultrasonic waves are reflected by boundaries with different acoustic characteristics (acoustic impedance) within the body.
- 3) The transducer is also used to receive reflected ultrasonic waves. The transducer vibrates mechanically due to the received ultrasonic waves and converts mechanical vibrations into electric energy. Electric signals are converted to shades of brightness by brightness modulation to obtain an image.

1.3. Intended Use

The transrectal probes EUP-R54AW-19 and EUP-R54AW-33 are designed for transrectal examination.

1.4. Composition

The probe components of EUP-R54AW-19 or EUP-R54AW-33 are as follows:

- 1) Transrectal Probe EUP-R54AW-19 or
EUP-R54AW-33 1 piece
- 2) Instruction manual..... 1 copy

WARNING

The probes are not sterilized when shipped, and they must be cleaned and disinfected / sterilized prior to the first use.

1.5. Accessories

1.5.1. Probe cover

Condom or protection sleeve for single use (Disposable) protects the probe against contamination. Use only dry type, lubrication free condom or protective tube sleeve (ref. to Suppliers List).

Lubrication may destroy the probe surface. Product made of Latex rubber may create allergic reactions. Use of non-allergic condom or sleeve is strongly recommended. Depending on examination procedure, use of sterile ultrasound gel is recommended. Sterile saline for better contact between sleeve and organ.

Take care for proper waste handling of used condom or protection sleeve.

1.5.2. Waterproof box EZU-WB1 (Option)

- 1) Waterproof box EZU-WB1 1 piece
- 2) Airtight tester..... 1 piece
- 3) Instruction Manual..... 1 copy

This accessory is necessary for protecting the probe connector against liquid when the probe is disinfected by washer-disinfector. About how to connect this accessory to the probe connector, refer to the instruction manual of Waterproof box EZU-WB1.

1.6. Construction

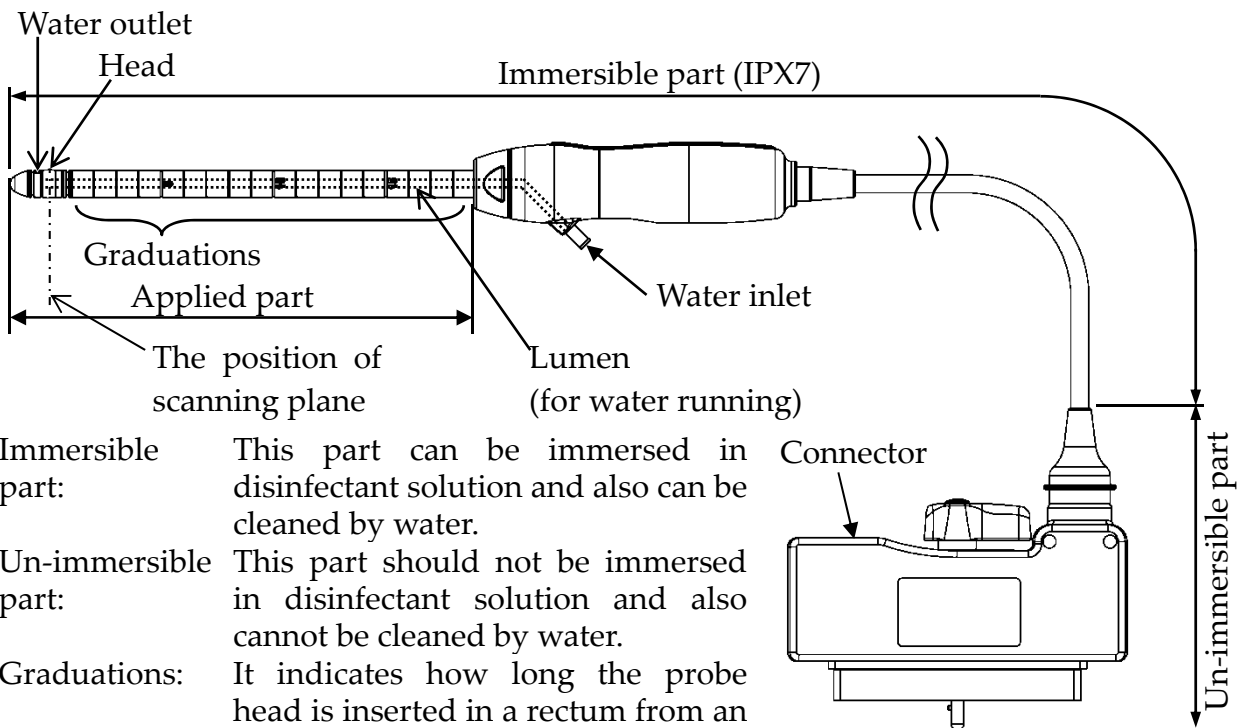

- Immersible part: This part can be immersed in disinfectant solution and also can be cleaned by water.
- Un-immersible part: This part should not be immersed in disinfectant solution and also cannot be cleaned by water.
- Graduations: It indicates how long the probe head is inserted in a rectum from an anus.

Fig. 1 External view

NOTE

The graduation marker is originated from the position of scanning plane. Probe distal end is still further by 18mm from the scanning plane.

2. Inspection before Use

Prior to use, the probe must be carefully inspected that it is appropriate for use. If not, do not use the probe and immediately contact a service support.

2.1. Inspection for appropriate connection

Confirm that the system is correctly operating. Refer to the instruction manual for the ultrasound diagnostic scanner.

2.2. Inspection for material surface

Visually inspect the surface of the probe and head, housing, the cable and the connector for any crack, scratch or denaturalization. If you find any damage, do not use the probe and contact a service support immediately.

3. Operation Procedure

3.1. Connection and Settings of Main Unit

- 1) Confirm that the probe is cleaned, disinfected or sterilized.
- 2) Connect the probe, operate the main unit, and adjust the image according to the instructions given in the operation manual for the main unit.
- 3) The relationship between the probe and the ultrasound image is as follows.
If "PROX." is displayed to the top-right position on the ultrasound image, it is observed from the side which the probe is inserted.
If "DISTAL" is displayed to the top-right position on the ultrasound image, it is observed from the reverse side which the probe is inserted.

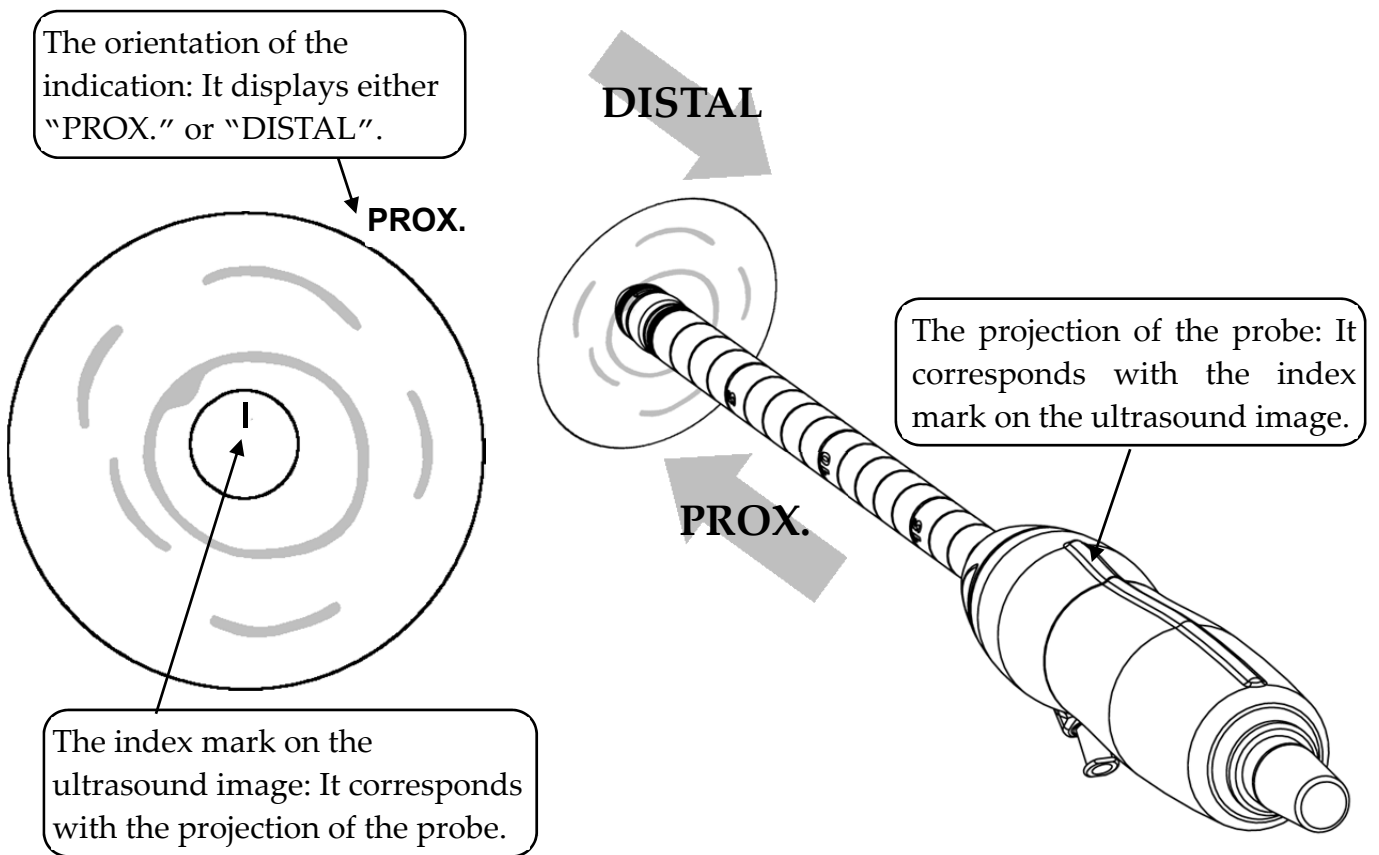

Fig. 2 The relationship between the probe and the Ultrasound image

3.2. General instruction

3.2.1. Preparation before starting diagnosis

- 1) Put a 1st protective sheath on the probe and cover the acoustic part of the probe. (see also in chapter 6.4 Transducer covers)

⚠ WARNING

Be careful of the following item when you use a protective sheath made out of latex. The latex may cause such allergic reactions as itching, rubor, urticaria, swelling, fever, dyspnea, wheezing, depression of blood pressure, shock and so on. If you observe any of above-mentioned symptoms in your patient during the operation, stop the use of protective sheath immediately and take an appropriate treatment to the patient.

- 2) Tie the 1st protective sheath by adhesive tape. (See Fig. 3.)
- 3) Apply sterilized jelly to the acoustic part of the probe on the 1st protective sheath.

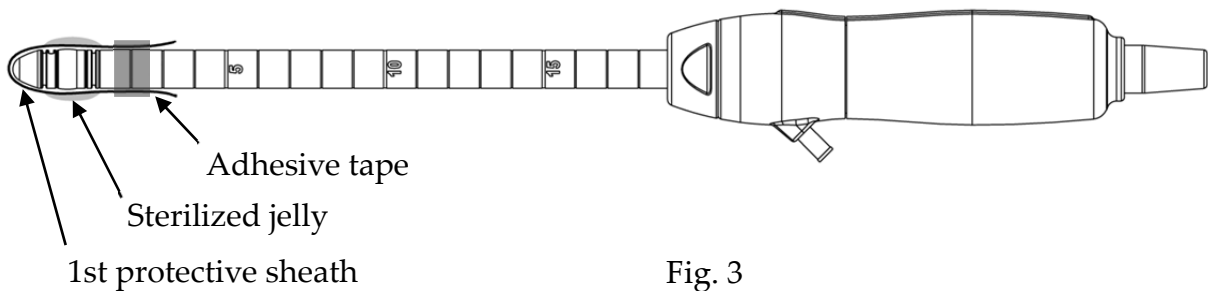

- 4) Put a 2nd protective sheath on the probe and cover the insertion part of the probe. (See Fig. 4.)

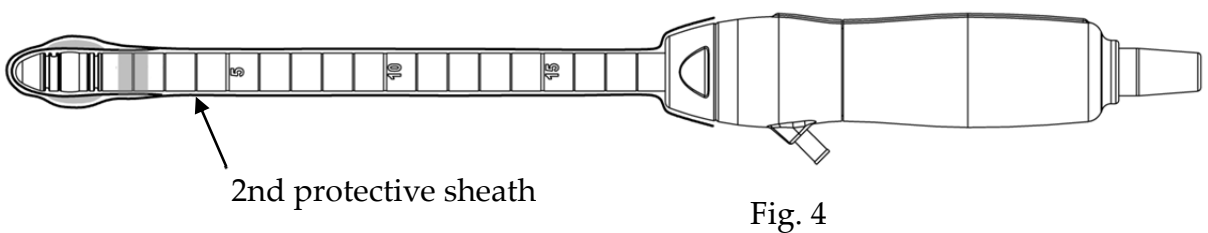

- 5) Fill the 1st protective sheath with physiological saline and remove air bubbles.

3.2.2. Insertion of the probe into body

- 1) Insert the probe into anus.
- 2) Inject the physiological saline into the 1st protective sheath by the syringe.
- 3) Locate the observation site by turning the probe and adjust the insertion depth.
- 4) Adjust the image for best B-mode display by adjusting TGC gain control or if necessary US-Power and depending of the size of the object also the scale range.
- 5) After observation, return the physiological saline from the 1st protective sheath into the syringe. After making sure the physiological saline is returning into the syringe, remove the probe from anus.

3.2.3. How to remove the protective sheaths

- 1) Remove the 2nd protective sheath first.
- 2) Untie adhesive tape and remove the 1st protective sheath.

CAUTION

- Do not use sharp or edged tools like tweezers to avoid a cut or a break to a probe head when removing protective sheaths covering a probe.
- Do not grab around a probe head and pull protective sheaths from a probe. This exerts stress and may cause damage against a probe head.

3.2.4. After use of the probe

After use of the probe, remove the protective sheath, clean and disinfect or sterilize the probe.

4. Cleaning, Disinfection and Sterilization

Take care about clean circumstances before using the probe on the next patients. If processors reprocess this equipment, refer to these instructions.

WARNINGS	<ul style="list-style-type: none"> - Lumen for the probe requires particular attentions during all processes. - The probe is delivered unsterile. Prior to the first use, reprocess the probe. - Do not exceed 60 °C - Probe connector has no water resistance. If washer-disinfector is used, connect the waterproof box to the probe connector certainly.
Limitations on reprocessing	<ul style="list-style-type: none"> - The probe is not completely submergible (see figure 5). Parts which are not submergible can only be disinfected by wipe disinfection.
Transportation before using	<p>Sterile pouch or container should be kept between transportation from Central Sterile Supply Department (CSSD) to operating room. Be careful that no damages are applied to sterile pouch or container for transportation.</p>

Levels of reprocessing requirements:

Depending on the application of the product and with regard to risk evaluation the user has to classify the medical device according to the current Medical Device Directive for processing of medical devices as uncritical, semi-critical or critical. Supporting information concerning this topic is listed in the table below. The user is responsible for correct classification of the medical device.

Classification	Definition	Processing
uncritical	Application part only contacts intact and uninjured skin	Cleaning Disinfection
semicritical	Application part contacts mucosa (intracavitary application)	Cleaning Disinfection (Disinfectant with virucidal effect)
critical	Application part contacts intracorporeal tissue directly (operative application)	Cleaning Disinfection (Disinfectant with virucidal effect - minimum) Sterilization

According to intended use the Transrectal Probes EUP-R54AW-19/33 are classified as semicritical.

Flowchart of reprocessing process of this probe is as follows.

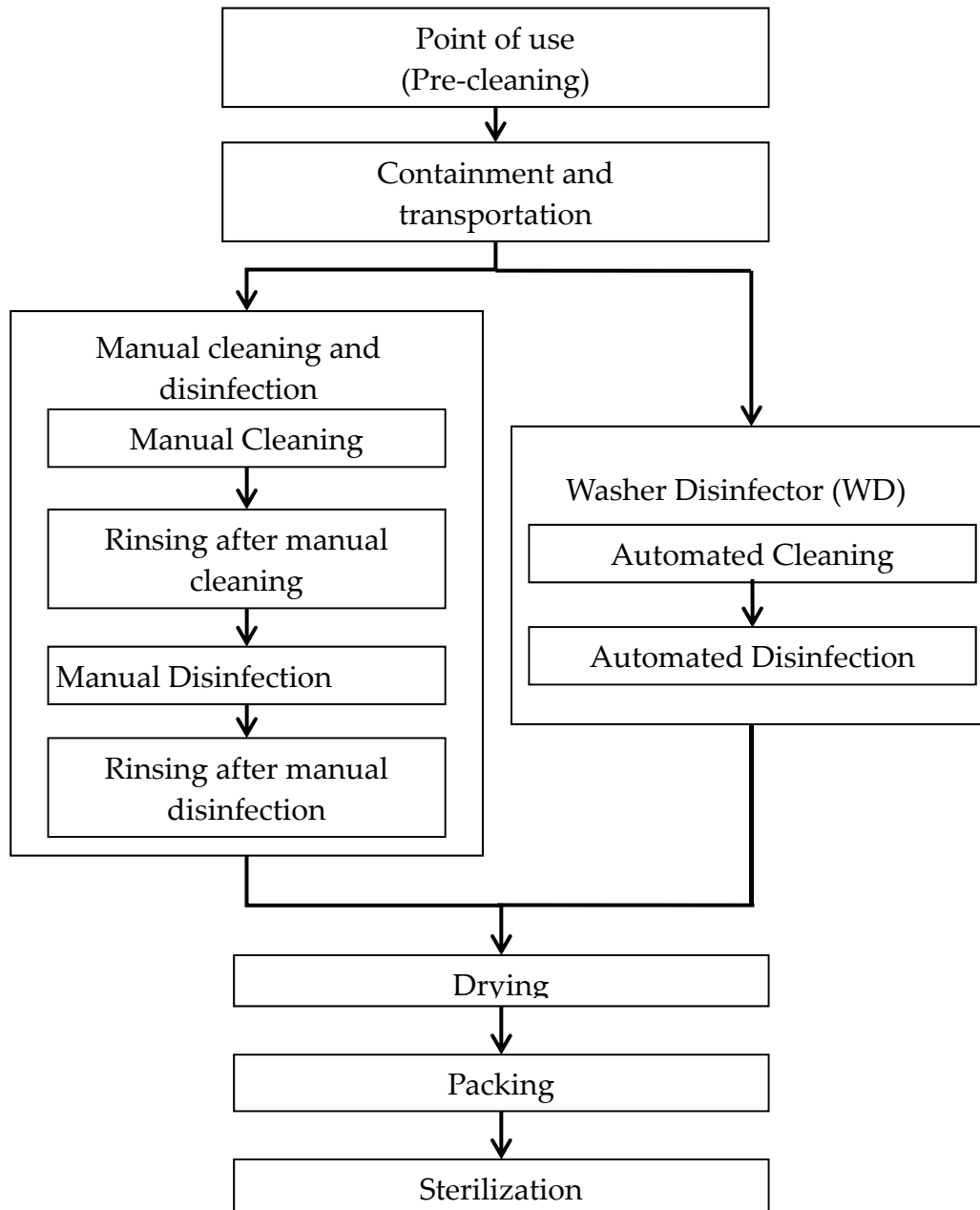

4.1. Point of use (Pre-cleaning)

In the operating room after use of the probe



- 1) Remove the protective cover
- 2) Flush the lumen of the probe directly after use with 50 ml deionized water/tap water using a 50 ml syringe (adaptation of the syringe to the water inlet of the probe).
- 3) Flush patient's blood or fluid by tap water until the surface of the probe looks visually clean.
- 4) Wipe the whole surface of the probe by gauze pad.
- 5) Twist off the metal ring between application part and probe holder. The metal ring has to be cleaned and disinfected separately.

4.2. Containment and transportation

Putting the contaminated equipment into exclusive shock and damage proof container for transportation is recommended. It is recommended that instruments are reprocessed as soon as possible and not later than 4 hours after usage.

4.3. Manual Cleaning and disinfection

Prepare following items before manual cleaning and disinfection:

- a) Detergent: Cidezyme (Johnson & Johnson, #2258) or another cleaning agent with approved material compatibility for this medical device.
- b) Disinfectant: Cidex OPA (Johnson & Johnson, # 20391) or another disinfectant with approved material compatibility for this medical device.
- c) Cleaning brushes if applicable, i.e. REF 09050, Interlock, i.e. Pentax CS3025S (cleaning the lumen of the water channel)
- d) Two tanks, one for cleaning and one for disinfection - optional: 1 additional tank for rinsing with deionized/tap water (sufficient size for immersion of the submergible part of the probe at full length)
- e) Syringe 50 ml with Luer-lock
- f) Soft, fluff free cloth or single use towel
- g) Personal protective equipment (gloves, water repellent protective skirt, face protection mask or protective glasses, see also instructions of the manufacturer for the detergent and the disinfectant)

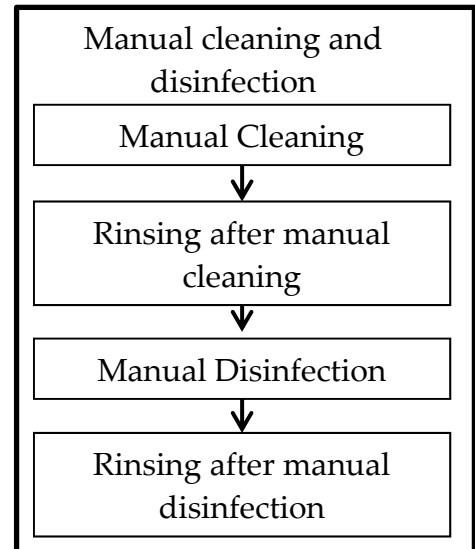

Manual Cleaning:

Preparation of the detergent solution in a tank with cold water (please follow the instructions of the detergent manufacturer concerning application, dilution and contact time).

- 1) The temperature of the detergent solution should be between 15-30 °C, concentration is 1.6%. Please note the minimum contact time of the detergent in the manufacturer's instruction. If a different detergent is used, follow the manufacturer's instructions.
- 2) Immerse the submergible part of the probe without connector into the diluted detergent solution. Wipe the submergible part of the probe and the metal ring under the surface of the detergent solution with a soft cloth to remove all visible soil.
- 3) Fill the water channel completely with detergent solution by using the syringe via the Luer inlet. The lumen of the probe is rinsed 5 times under the surface of the detergent solution with 50 ml diluted detergent. Fill and drain the channel by using the syringe. Afterwards remove the syringe.

- 4) Insert the cleaning brush into the water channel via the Luer inlet until the distal end of the channel is reached. Brush the whole length of the lumen of the probe 5 or more times with an applicable brush. Clean the oval, distal end on the opposite side of the water channel 5 times with the brush accordingly. In addition all submergible parts of the probe are brushed until visually clean.
- 5) After brushing the water channel is rinsed again five times with the detergent solution. Fill and drain the channel by using the syringe.
- 6) The submergible part of the probe and the metal ring stay in the detergent solution according to the specified contact time of the detergent manufacturer.
- 7) Wipe the non-submergible parts of the probe with a soft cloth dipped with the detergent solution.
- 8) Rinse the probe and the water channel with running tap water for 1 minute. Please note that the water flows through the channel completely.
- 9) Alternatively to above step, immerse the submergible part of the probe and the metal ring in a tray filled with deionized water/tap water for 5 min. and rinse the lumen of the probe with 50 ml deionized water/tap water five times.
- 10) Visually check the outer surface of the probe for cleanness. If necessary, use magnifying glass for visually check. If there is still soil visible, repeat all above steps.

Manual disinfection:

- 1) Preparation of the disinfection solution in a tank with cold water (please follow the instructions of the disinfectant manufacturer concerning application, concentration, microbiological efficiency, service life and contact time).
- 2) Before immersing the equipment, it is recommended to test the concentration of disinfectant solution before each usage. The solution Cidex OPA is ready for use and does not need to be diluted. Test strips to verify that the appropriate concentration of Cidex OPA is correct are available by manufacturer. Test strips will indicate a concentration above the Minimum Effective Concentration (MEC). Temperature of disinfectant solution should be minimum 20°C. The minimum contact time is 5 minutes. If a different disinfectant is used, follow the manufacturer's instructions.
- 3) Immerse the submergible part of the probe and the metal ring into the disinfectant (see Fig. 5). Fill the water channel completely with the disinfectant solution by using the syringe via the Luer inlet and rinse the lumen of the probe 5 times with 50 ml disinfectant under the surface of the solution. Set a clock to insure the recommended contact time which is 5 minutes. For sufficient cleaning no air blowing inside the channel is required.

- 4) Rinse the probe and the water channel with running deionized water for 1 minute. Please note that the water flows through the channel completely.
- 5) Alternatively to above step, immerse the submersible part of the probe and the metal ring in a tray filled with deionized water for 5 min. and rinse the lumen of the probe with 50 ml deionized water five times by using the syringe.
- 6) Visually check the lumen and the outer surface of the probe for leavings of the disinfectant. If necessary, repeat the rinsing.

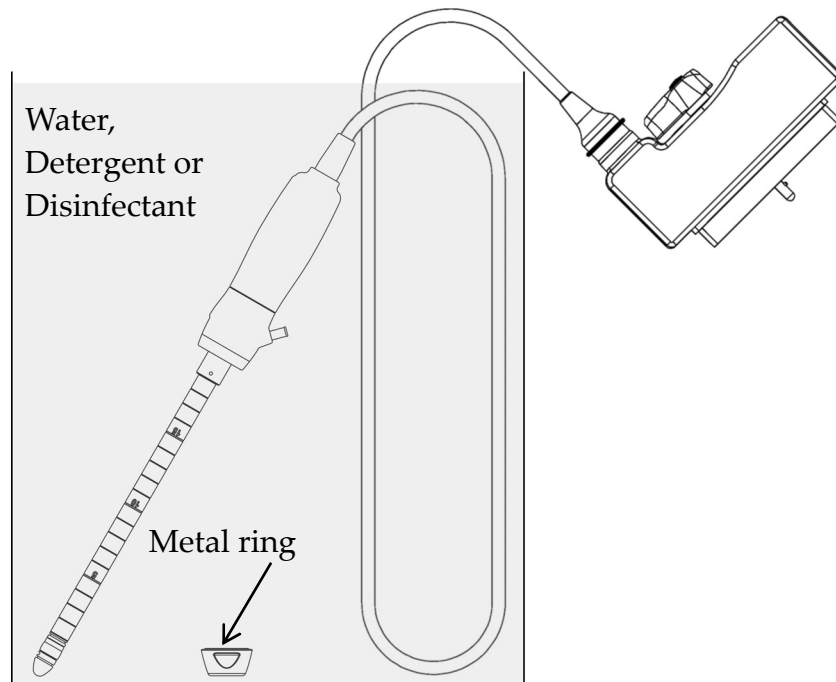
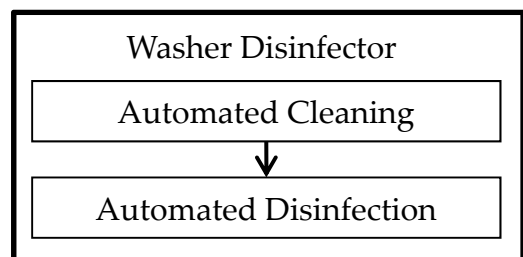

Fig. 5 Immersion of the probe

4.4. Automated cleaning and disinfection

The following items must be provided prior to automated cleaning and disinfection:

- a) Washer disinfector: according to DIN EN ISO 15883 with chemo-thermal program (temperature: max 60 ° C).
- b) Waterproof box for probe connector EZU-WB1
- c) Detergent: Korsolex® Endo-Cleaner (Bode Chemie; # 972 020) or another cleaning agent with approved material compatibility for this medical device
- d) Disinfectant: Korsolex® Endo Disinfectant (Bode Chemie; # 972 030) or another disinfectant with approved material compatibility for this medical device
- e) Washer disinfector accessories:



Adaption for tubular bodies, for fixation and connection of the probe to WD (Medisafe; MED 1600.31)

1) The parameters of the cleaning and disinfection of the device are as follows:

Program step	Water (40 l)	Dosage (ml/l)	Temp. (°C)	Time (min)
Pre-Rinse	Cold water	-	-	5
Cleaning	Deionized water	5 (0.5%)	50	5
Rinse	Deionized water	-	-	1
Disinfection	Deionized water	10 (1%)	55	5
Rinse	Deionized water	-	-	1
Rinse	Deionized water	-	55	1
Drying	-	-	55	15

- 2) Connect the waterproof box EZU-WB1 to the probe connector and confirm there is no air leak by the tester. About detail information, refer to the instruction manual of the waterproof box EZU-WB1.
- 3) Perform the wipe disinfection of the instrument ports to be connected to the washer disinfecter.
- 4) Connect the Luer-lock connector of the probe to the adaption for tubular bodies with Luer-Lock of the WD. Decomposed accessories (metal ring) are placed directly into baskets.
- 5) After closing the door, start the chemo-thermal program
- 6) After the end of the program, open the door.
- 7) Remove the probe and accessories and check whether they are dry. If not, proceed as described under drying

4.5. Drying

Drying

- 1) Wipe the probe with single use, fluff free wipe or towel for removing moisture on the surface of the equipment.
- 2) Dry the lumen of the probe by an air gun with compressed air. The compressed air should be filtered with a sterile filter that removes air particles of less than 0.2 µm. Dry until no visible moisture is left.
- 3) If using drying heater for medical equipment, the temperature limit is a maximum of 60 °C. Dry until no visible moisture is left.
- 4) If using natural drying, temperature range should be between 15-30 °C for a minimum time of 4 hours.

4.6. Inspection

There are no abnormal exterior damages such as cracks, scratches or deformations on the surface of the equipment. Don't use the probe in case of existing damage.

4.7. Packaging

Store the disinfected probe in a dustproof environment until next application.

Before sterilization, pack the cleaned and disinfected probe in a sterile barrier system for plasma sterilization (for example Polypropylene fleece or transparent package out of Polyethylene film and Tyvek®).

Additionally the probe can be placed on plastic mesh wires sufficient for plasma sterilization supplied by the manufacturer and packed in the material mentioned above afterwards.

The probe can be packed in a simple or double packing.

The probe should be packed either in Polypropylene fleece or in transparent package.

The package has to be large enough to avoid tension to the sealing seam.

Check the sealing seam after hot sealing for any defects.

The sealing machine should be designed for sealing transparent package out of Polyethylene film and Tyvek®.

In case of processing mistakes or defects the package has to be opened again and the device has to be packed and sealed again.

4.8. Sterilization

Sterilization methods of ethylene oxide gas and STERRAD® are available to this probe. Follow the instructions of the sterilizer manufacturer regarding usage, temperature and sterilization-time etc. Handling and maximum input to chamber of sterilizer should be according to operation manual of the sterilizer.

Sterile conditions of applicable sterilization methods are as follows.

Sterilization Method	Condition
Plasma Sterilization: STERRAD® 50, 100S or 200 (*)	Short Cycle
Plasma Sterilization: Sterrad® NX or 100NX (*)	Standard cycle
ETO Sterilization	<ul style="list-style-type: none"> ➤ Gas Type: 10% EO/ 90% HCFC ➤ Temperature: 50-55 °C ➤ Exposure Time: More than 120 minutes ➤ Pressurization: 162-200kPa ➤ Depressurization: 13-8kPa ➤ Relative humidity: 40-90% ➤ Aeration is minimum 12 hours

* STERRAD® systems are manufactured by "Johnson & Johnson"

⚠ WARNING

- 1) Before performing sterilization, check that the operation data of sterilizer are in conjunction with min. and max. data applicable for the probe.
- 2) Do not sterilize the probe by Steam Autoclaving. If you autoclave it, it suffers serious damage and will be not functional.

Figure:

- 1) Put the probe into TYVEK pouch.

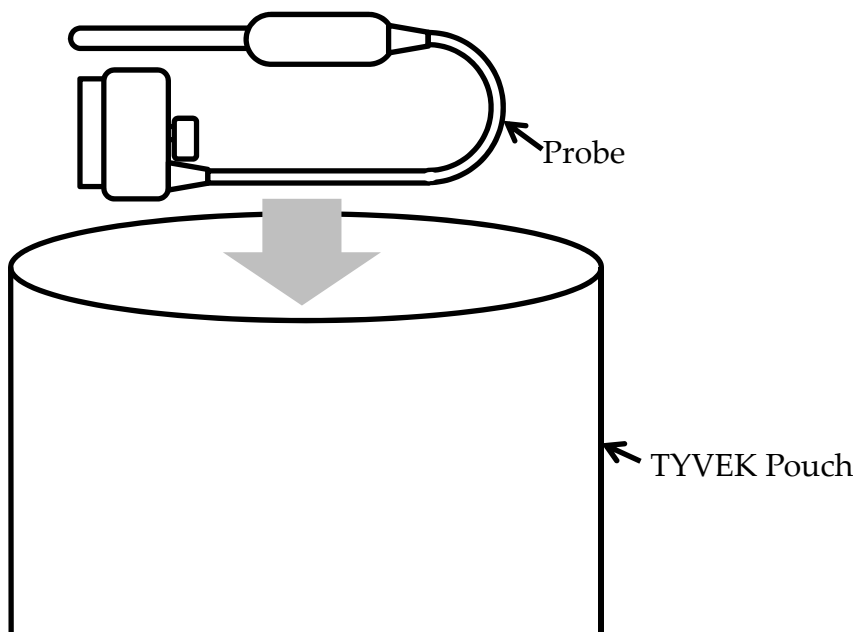

- 2) Seal the TYVEK Pouch by heat sealer. After sealing, make sure to seal the TYVEK Pouch completely.

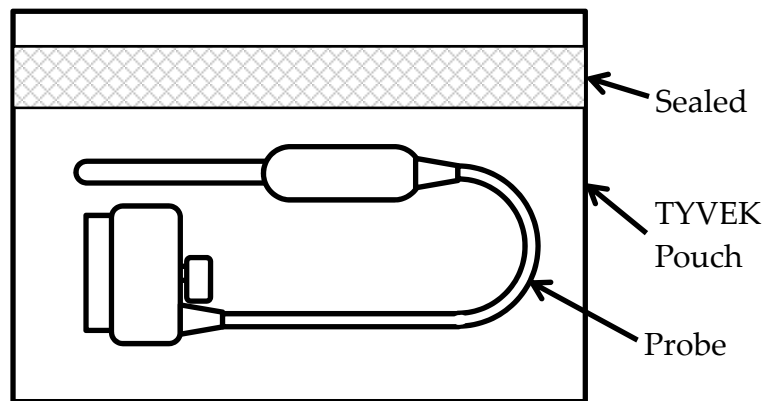

- 3) Put the probe in the Pouch into tray or plastic mesh wire for sterilization.

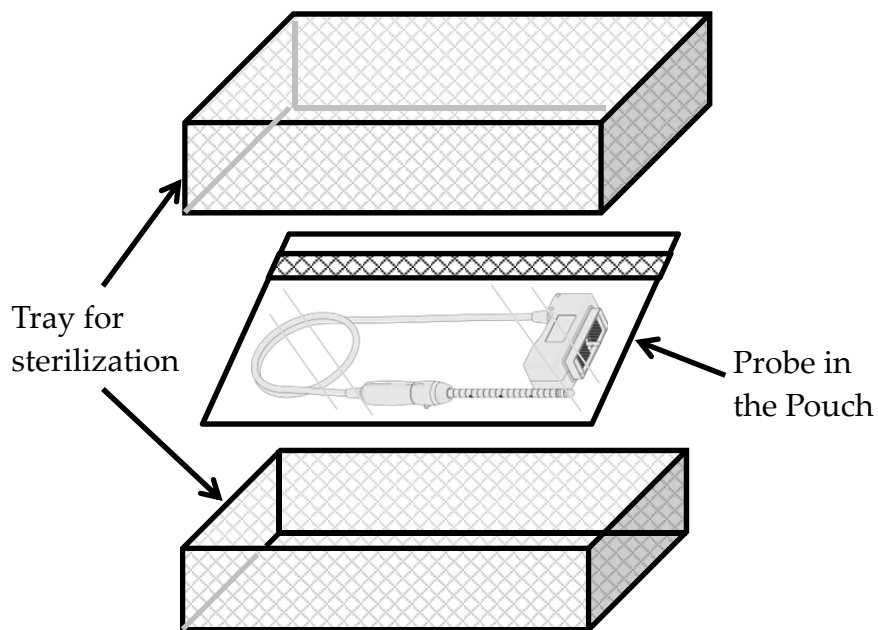

4.9. Storage



Store the equipment in a cool and dark space to avoid high temperature, humidity and direct sunlight. Limitations for the time for sterilized equipment belong to package.

5. Safety Precautions

WARNING

- Never use the probe if the probe head, shaft or cable are cracked or damaged.
- The ultrasound gel attached to the ultrasound scanner, as one of accessories is not sterile so never use it with EUP-R54AW-19 and EUP-R54AW-33.
- Warning is case of using probe covers which latex is contained to. The latex may cause such allergic reactions as itching, rubor, urticaria, swelling, fever, dyspnea, wheezing, depression of blood pressure, shock and so on. For the patients suspected of latex allergy, do not use the latex-containing medical devices. If you observe any of above-mentioned symptoms in your patient during the operation, stop the use of the latex-containing medical devices immediately and take an appropriate treatment to the patient.

CAUTION

- By examination of an early pregnancy the exposure time shall be as short as possible. Start examination with acoustic output power set to L (Low).
- The probe connector is not waterproof. Do not allow liquid to contact the connector.
- Do not drop, hit or bent the probe.
- Use only water, detergents and disinfectants in the suppliers list. Between uses store the probe holder off scanner.
- The probe is not delivered disinfected or sterilized.

6. Specifications

6.1. EUP-R54AW-19

Probe Type:	EUP-R54AW-19 Transrectal Probe
Center frequency:	7.5MHz
Technology:	Micro convex array Probe
Dimensions:	See Fig. 7.
Weight:	Approx. 1.1kg (incl. cable and connector)
Scanning angle:	360°
Insertion length:	190mm
Probe materials:	Bio-compatible allergy free components
Acoustic output:	According to IEC60601-2-37 (See Main Unit manual.)
Applicable system:	Depending on production and upgrade status. For detailed information contact a service support.
Classification:	MDD classification IIa.
Cleaning:	Applicable detergents are listed in the suppliers list
Disinfection:	Applicable disinfectants are listed in the suppliers list
Operating conditions:	
Ambient temperature;	25 – 35° C
Contact surface temperature (temperature of examinee);	Max. 42° C
Relative humidity;	30 – 85% (Subject to no condition)
Storage conditions:	
Ambient temperature;	-10 – +55° C
Relative humidity;	10 – 95% (subject to no condensation)
Atmospheric pressure;	700-1060hPa

6.2. EUP-R54AW-33

Probe Type:	EUP-R54AW-33 Transrectal Probe
Center frequency:	7.5MHz
Technology:	Micro convex array Probe
Dimensions:	See Fig. 8.
Weight:	Approx. 1.2kg (incl. cable and connector)
Scanning angle:	360°
Insertion length:	330 mm
Probe materials:	Bio-compatible allergy free components
Acoustic output:	According to IEC60601-2-37 (See Main Unit manual.)
Applicable system:	Depending on production and upgrade status. For detailed information contact a service support.
Classification:	MDD classification IIa.
Cleaning:	Applicable detergents are listed in the suppliers list
Disinfection:	Applicable disinfectants are listed in the suppliers list
Operating conditions:	
Ambient temperature;	25 – 35° C
Contact surface temperature (temperature of examinee);	Max. 42° C
Relative humidity;	30 – 85% (Subject to no condition)
Storage conditions:	
Ambient temperature;	-10 – +55° C
Relative humidity;	10 – 95% (subject to no condensation)
Atmospheric pressure;	700-1060hPa

6.3. Suppliers List

The products listed below are seriously tested and approved for use with the Transrectal probe EUP-R54AW-19/33.

Table 1 Suppliers List

Product name	manufacturer	purpose
Waterproof box for probe connector EZU-WB1	Hitachi, Ltd	Waterproof box for probe connector
Cleaning brush REF 09050	Interlock	Cleaning brush
Cleaning brush CS3025S	Hoya Pentax	Cleaning brush
Cidezyme®	Johnson & Johnson	Enzymatic detergent
CIDEX OPA®	Johnson & Johnson	Disinfectant
CIDEX OPA test strips	Johnson & Johnson	Test strip for verifying concentration of Cidex OPA
CIDEX®	Johnson & Johnson	Disinfectant
CIDEX® plus 28day solution	Johnson & Johnson	Disinfectant
CIDEX test strips	Johnson & Johnson	Test strip for verifying concentration of Cidex
Korsolex Endo-Cleaner	Bode Chemie	Detergent for Washer-disinfector
Korsolex Endo Disinfectant	Bode Chemie	Disinfectant for Washer-disinfector
ALKAZYME	ALKAPHARM	Cleaner
Bodedex forte	BODE CHEMIE	detergent
ALKACIDE	ALKAPHARM	Disinfectant
ANIOXYDE 1000	Laboratories ANIOS	Disinfectant
Gigasept® AF forte	Schülke & Mayr	Disinfectant
Gigasept® FF	Schülke & Mayr	Disinfectant
Korsolex extra	BODE CHEMIE	Disinfectant
METRICIDE®	Metrex Research, Inc.	Disinfectant
METRICIDE® 28	Metrex Research, Inc.	Disinfectant
STERANIOS 2%	Laboratories ANIOS	Disinfectant
Product name	manufacturer	purpose
Tristel 1 Day	Tristel Company	Disinfectant
Tristel Multi-Shot	Tristel Company	Disinfectant
WAVICIDE-01®	Wave Energy Systems	Disinfectant
ASPHENE® SPRAY	Laboratories RIVADIS	Disinfectant Spray

Please contact your local distributor for a current version of the "Disinfectant/Sterilization Method Compatibility for Ultrasound Probe and Accessory List".

6.4. Transducer covers

Specification for short probe cover (first protective sheath) adaptive for probe EUP-R54AW-19 and EUP-R54AW-33:

- length approx. 100mm, inner diameter over 13mm
- sterile if possible
- not latex if possible

e.g. samcoCover/Cross Healthcare, Ltd. REF 7.584.420, Size: FU 100

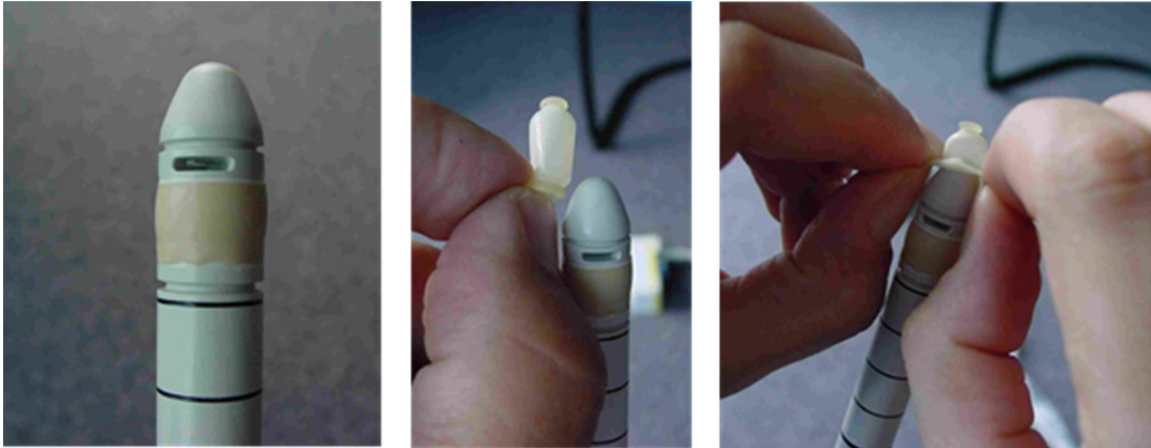

Figure 6: Application of first protective sheath (e.g. samcoCover/Cross Healthcare, Ltd. REF 7.584.420)

⚠ CAUTION

Both sides of the rings of samcoCover/Cross Healthcare, Ltd. REF 7.584.420 balloon are little bit tight against the grooves of the tip of probe. Handle with care when mounting and removing it to/ from the probe. If the cover is mounted or remove roughly, the acoustic part may suffer serious damage and be unfunctional.

Specification for long probe cover (second protective sheath) adaptive for probe EUP-R54AW-19:

- length approx. 250mm, inner diameter over 15mm
- sterile if possible
- not latex

e.g. Cross Healthcare, Ltd. REF: 220.00.02 Size: 20x200mm, non-sterile

e.g. Cross Healthcare, Ltd. REF: 7.206.020 Size: 20x200mm, sterile

Specification for long probe cover (second protective sheath) adaptive for probe EUP-R54AW-33:

- length approx. 350mm, inner diameter over 15mm
- sterile if possible
- not latex

e.g. Cross Healthcare, Ltd. REF: 220.00.04 Size: 26x300mm, non-sterile

e.g. Cross Healthcare, Ltd. REF: 7.206.040 Size: 26x300mm, sterile

7. Disposal of the probe

Recycle or dispose the equipment properly in compliance with your organizational rules and your local laws.



Before disposing the equipment, disinfect or take other infection-prevention measures. Disposal of the equipment without taking the proper preventative measures can lead to infection.

Waste Electrical and Electronic Equipment (WEEE) Directive

The illustration on the right is required by the EU WEEE Directive to appear on all electrical and electronic equipment.

For proper disposal of this product in an EU nation, contact an EU office or agency and observe appropriate local and national regulations and laws.



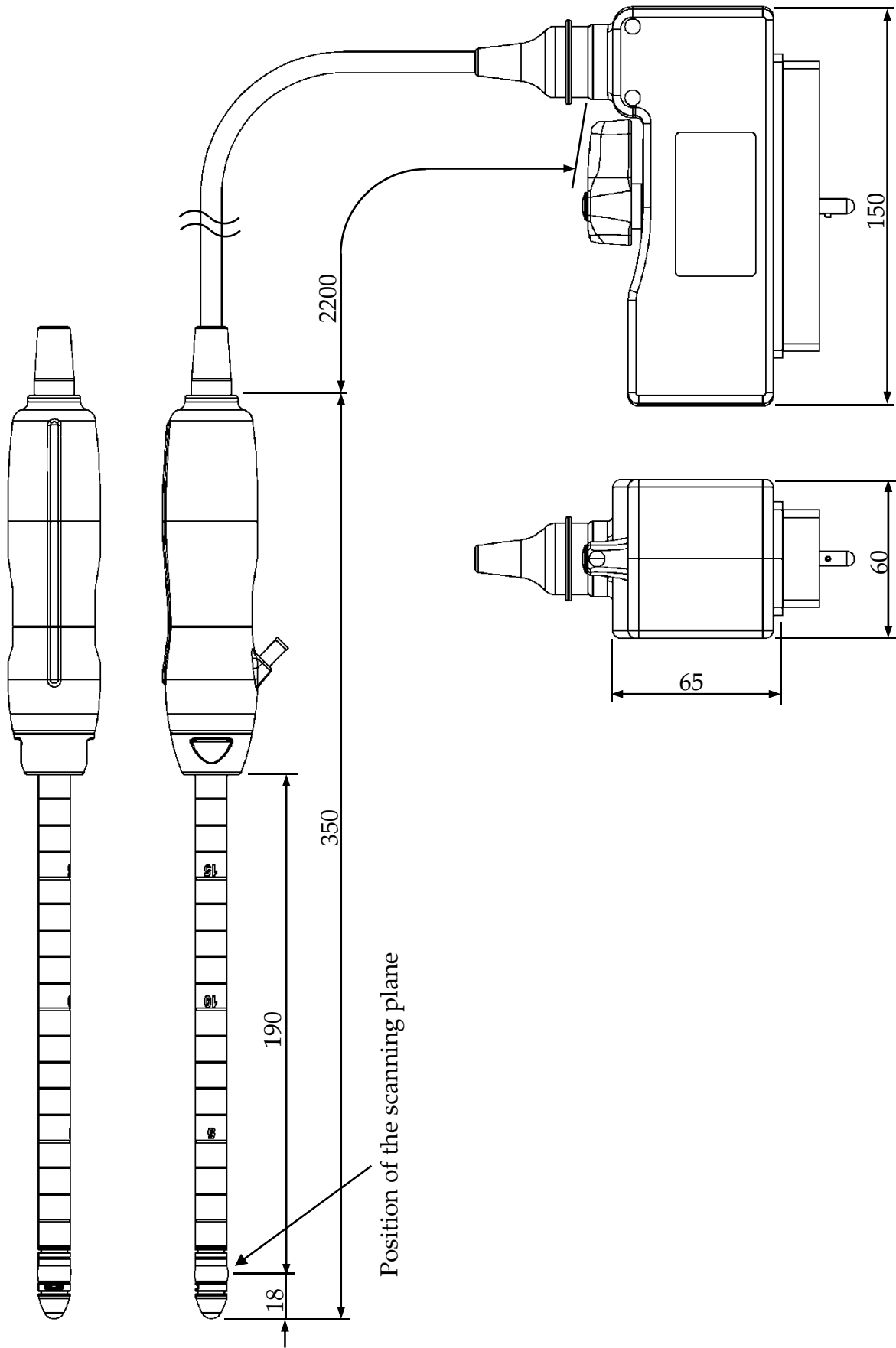

Fig. 7 Dimensions of EUP-R54AW-19

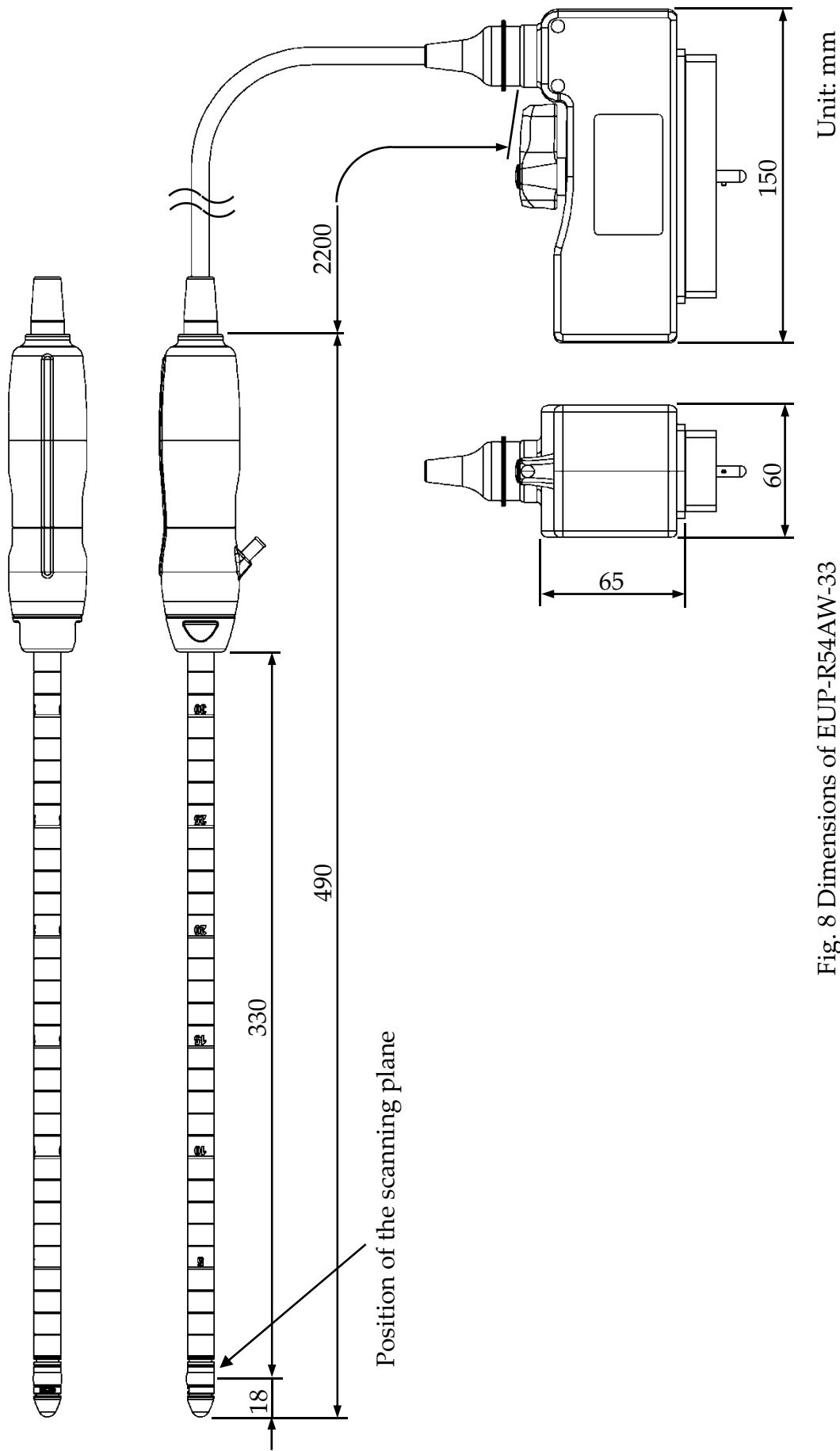

Fig. 8 Dimensions of EUP-R54AW-33