

L43K Probe
Instruction Manual
Specification
MN1-6025 Rev. 6

Notes for operators and responsible maintenance personnel

- ★ *Please read through this Instruction Manual as well as the separate Instruction Manual “Safety (MN1-5984)” and “Cleaning, Disinfection and Sterilization (MN1-6369)” carefully prior to use.*
- ★ *Keep this Instruction Manual together with the ultrasound diagnostic instrument for any future reference.*



© Hitachi, Ltd. 2014, 2017. All rights reserved.

Introduction

This is the instruction manual for L43K probe. The probe is available by connecting to Hitachi's ultrasound diagnostic instrument. It is operated by grasping with a forceps and can be mainly used for observation of human internal organs during surgery.

Prior to use, read this manual as well as the separate instruction manual "Safety" in which information for safe use is provided.

The probe bears the CE mark but the mark is valid only when the probe is connected to the ultrasound diagnostic instrument bearing the CE mark.

Symbols used in this document

Safety information is classified into Danger, Warning, Caution, and Note according to the level of hazard. Those terms are used in the safety information provided to prevent hazards and injuries to the operator or patients.

Danger

Indicates an imminently hazardous situation which, if not avoided, will result in death or serious injury to the operator or patient.

Warning

Indicates a potentially hazardous situation which, if not avoided, could result in death or serious injury to the operator or patient.

Caution

Indicates a potentially hazardous situation which, if not avoided, may result in minor or moderate injury to the operator or patient, or property damage only.

Note

Indicates a strong request concerning an item that must be observed in order to prevent damage or deterioration of the equipment and also to ensure that it is used efficiently.

The type of safety information is indicated by the symbols below.



This symbol means that attention is required.



This symbol means that the described action is prohibited.



This symbol means that the described action is mandatory.

CONTENTS

| | |
|--|---|
| 1. General Information..... | 1 |
| 1-1. Intended use..... | 1 |
| 1-2. Classification of ME equipment..... | 1 |
| 1-3. Standard components | 1 |
| 1-4. Options | 2 |
| 2. Specifications and Parts name..... | 3 |
| 2-1. Specifications..... | 3 |
| 2-2. Name of each parts..... | 4 |
| 2.3. Forcep | 5 |
| 3. Preparations before use | 6 |
| 3-1. Visual check | 6 |
| 3-2. Confirmation of cleaning and sterilization..... | 6 |
| 3-3. Operation check..... | 6 |
| 3-4. Probe insertion check | 6 |
| 4. Operation..... | 8 |
| 4-1. Insertion of the probe | 8 |
| 4-2. Operation..... | 8 |
| 4-3. Pulling out the probe | 9 |

This instruction manual contains 4 pages of front matter and 12 pages of the main content.

1. General Information

General information for the probe is provided below.



1-1. Intended use

The L43K transducer is intended for use by trained personnel (doctor, sonographer, etc.) for the diagnostic ultrasound evaluation during robotic/non-robotic intra-operative and laparoscopic procedures.

Please refer to the ultrasound diagnostic instrument instruction manual used with this probe for the probe intended use information.

Regarding with the connectable instrument, please refer to section 2-1. Specifications of this manual.

Please refer the section 2-3 Forcep for detailed of robotic/non-robotic.

| | |
|--|--|
|  Warning | |
|  | Do not use this equipment for other than its intended use. Otherwise it could cause burns or other injuries to the patient or operator. |

1-2. Classification of ME equipment

This probe is classified as follows according to IEC60601-1.

Please refer to the section 2-1 for the range of applied part, the part treated as applied part, and the range of IPX7.

- Classification based on the degree of protection against electric shock Type BF applied part
- Classification for protection against ingress of liquids IPX7 (Watertight equipment)
- Operation mode..... Continuous operation
- Method of sterilization..... Refer to the separate instruction manual
“Cleaning, Disinfection and Sterilization”

1-3. Standard components

The standard components of L43K probe are as follows.

- L43K Probe 1 set
- Storage case 1 set
- Instruction Manual
 - Specification (MN1-6025) 1 copy
 - Safety (MN1-5984) 1 copy
 - Cleaning, Disinfection and Sterilization (MN1-6369) 1 copy

1-4. Options

The following options are available for this probe.

- Reprocessing by liquid detergent, disinfectant or sterilant

Whole the probe is able to immerge into the liquids by putting the connector of the ultrasound probe to the waterproof case WP-001 as below table 1.

Precautions about the waterproof case, please refer to the instruction manual.

Table 1 Accessory for reprocessing by liquid detergent, disinfectant or sterilant

| Product Name | Product No. |
|-----------------|-------------|
| Waterproof case | WP-001 |

2. Specifications and Parts name

The specifications and the name of each part are provided below.

2-1. Specifications

Application: Intraoperative diagnosis
 Type of patient contact: Intraoperative
 Connectable instruments: ARIETTA 70 , ARIETTA 60, Noblus, ARIETTA Precision

NOTE:
 At the time of publication of this manual, the connectable diagnostic ultrasound instrument or instrument software version available with this probe is different for each country, please refer to the instrument instruction manual or contact your local Hitachi representative.

Field of view: 25.6mm
 Frequency: 7.0 MHz
 Cable length: 3.0 m
 Service life: 3 years
 Applied part: Probe tip including ultrasonic radiation part, see the section 2-2

Part treated as applied part: Cable up to 0.2 m length from the probe tip
 IPX7 range: See Figure 1 (In case that not putting the waterproof case to the ultrasound probe connector)
 In case that putting the waterproof case to the ultrasound probe connector, whole the probe from the tip of the ultrasound probe to the connector with Waterproof Case WP-001 is IPX7. range

Measurement accuracy: Refer to the instruction manual of the ultrasound diagnostic instrument
 External dimensions: See Figure 1

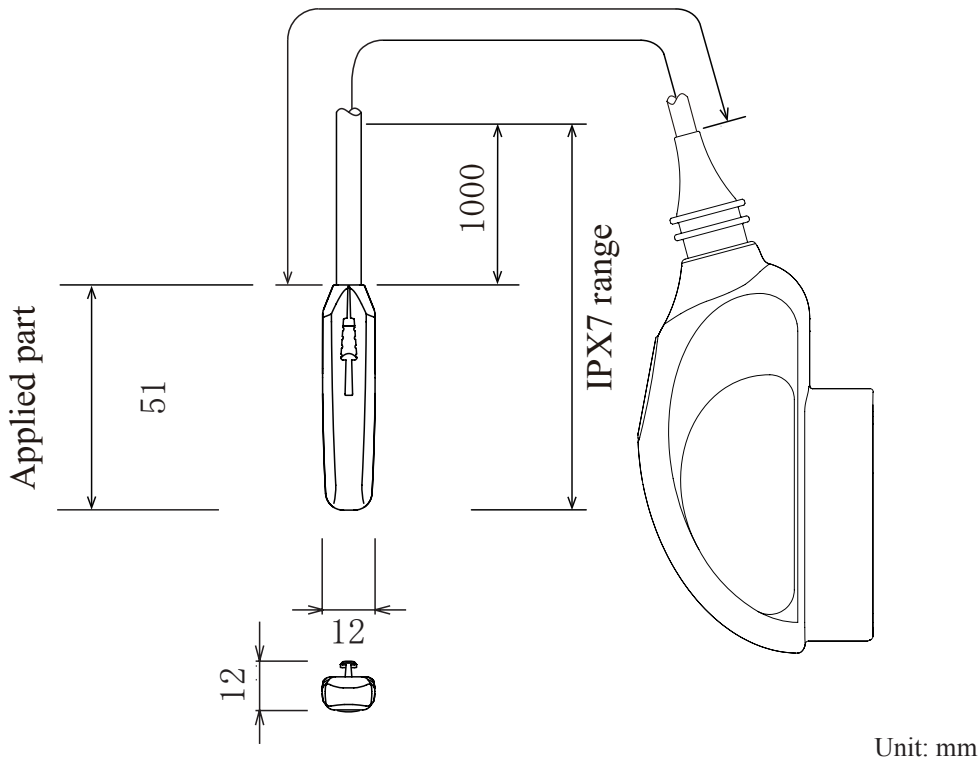

Remark: The tolerance for the dimensions is ±10%.

Figure 1 External View

2-2. Name of each parts

The name of each part is shown in Figure 2 and the explanation for each part is listed in Table 2.

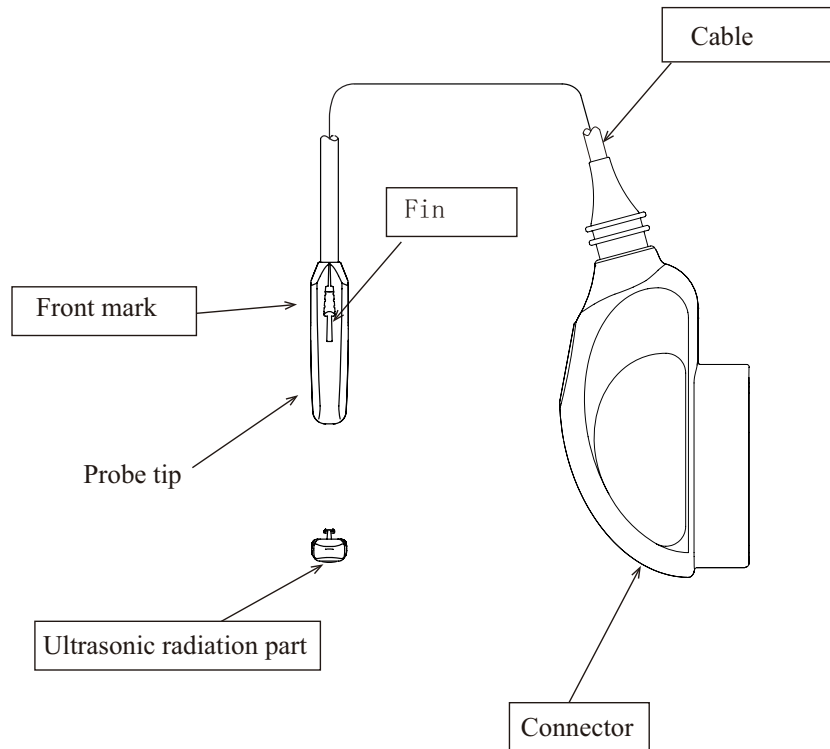

Figure 2 Name of each parts

Table 2 Name of each part and its explanation

| Name | Explanation |
|---------------------------|---|
| Ultrasonic radiation part | Ultrasound is radiated from this part. The electronic linear transducer is integrated underneath this part. |
| Front mark | The cable side corresponds to the side of the orientation mark on the image. |
| Fin | This part is gripped with a forceps during operation. |
| Cable | Cable transfers electric input/output signals. |
| Connector | The connector is connected to the ultrasound diagnostic instrument. |

| | |
|------------------|---|
| ⚠ Caution | |
| ⊘ | Do not pull, bend, twist, or apply excessive force to the cable. The probe may malfunction due to cable disconnection. |
| ⊘ | Do not subject the ultrasonic radiation part to hard impact. The impact may cause damage to the transducer, and that results in noise or no echo in the image. In most cases, the ultrasonic radiation part itself is not damaged because the part is made of elastic material. |

2.3. Forcep

Forcepses listed in the table 3 are recommended for using with the probe.

If you are unable to purchase the forceps, please contact our sales office.

Table 3 Forcep

| Product | No. | Product Name |
|-------------------|--------|--------------------------|
| AdTec® mini | PO305R | B.Braun Aesculap® |
| ProGrasp™ Forceps | 420093 | Intuitive Surgical, Inc. |

*ProGrasp is a Trademark of Intuitive Surgical, Inc.

 **Caution**

 Regarding the precautions of the forceps, please refer to its instruction manual.

3. Preparations before use

This chapter describes preparations needed to use the probe safely. Please prepare the probe prior to each use by following the instructions below.

3-1. Visual check

Visually check the probe tip, ultrasonic radiation part, cable, and connector.

If any holes, indentations, abrasion, cracks, deformation, looseness, discoloration, or other abnormalities are found, do not use the probe.

3-2. Confirmation of cleaning and sterilization

Confirm that the probe is certainly cleaned and sterilized. The degree of reprocessing depends on the intended use. Please refer to the separate instruction manual “Cleaning, Disinfection and Sterilization“ for cleaning and sterilization procedure.

3-3. Operation check

Connect the probe to the ultrasound diagnostic instrument and check that the displayed scan type and frequency correspond to those of the probe. Check also that there is no abnormality in the image.

3-4. Probe insertion check

Insert the probe into the trocar and make sure the probe can be smoothly inserted/removed.

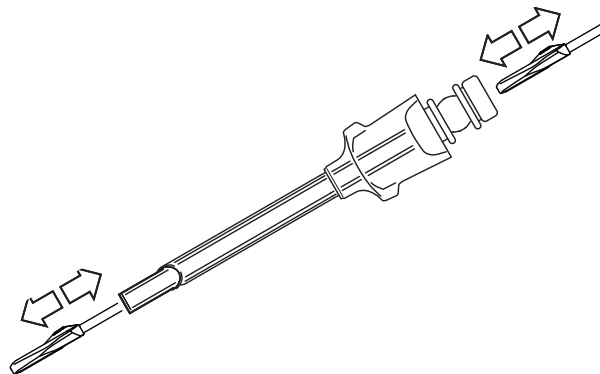

Remark: Please refer to the documentation supplied with the ultrasound diagnostic instrument for how to connect the probe and information displayed on the monitor.

If the probe is operated in still air, brightness on the top of the image may be non uniform, but this does not affect the performance of the probe.

Warning

Make preparations prior to each use.
 The operator and the patient may be injured if the equipment has any abnormality.
If any abnormality is found in the equipment, stop using it and contact our office written on the back cover.

 **Caution**



Do not use the probe if the displayed scan type and frequency do not correspond to those of the probe. Incorrect acoustic output can result in burns or other injuries to the patient. Contact our office written on the back cover.

4. Operation

This chapter describes the operation of the probe.

4-1. Insertion of the probe

Gently insert the tip of the probe into the insertion opening of the trocar.

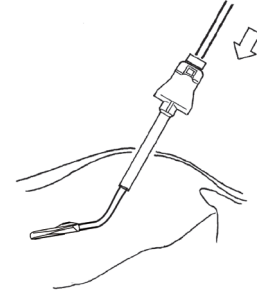

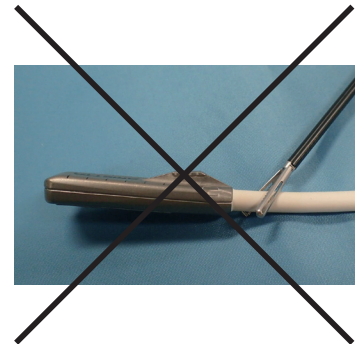
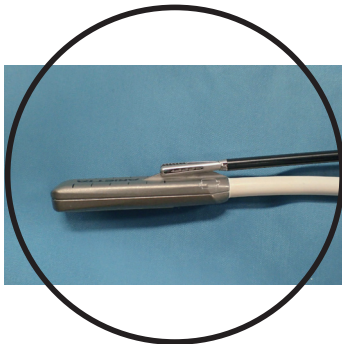

4-2. Operation

Grasp the fin with a forceps and place the ultrasonic radiation part of the probe onto the inner organ surface during surgery. An image of the region of interest is displayed on the monitor of the ultrasound diagnostic instrument. For details on displaying and adjusting the image, refer to the documentation supplied with the ultrasound diagnostic instrument.



Warning

-  Use an appropriate size trocar.
If an appropriate size trocar is not used, the probe may be damaged when inserted into the trocar. Use a trocar with a diameter of 12 mm or more. Please refer to 3-4 for preparations before use.
-  Do not insert and operate the probe forcibly, as this may cause injury to a patient.
Insert the probe without excessive force on the probe and the cable. If the probe cannot be inserted smoothly, stop using the probe.
-  Do not grasp the cable with forceps.
The probe may malfunction due to cable disconnection. Please operate by grasping the fin with forceps always.

| | |
|------------------|---|
| ⚠ Caution | |
| ⊘ | Do not operate the probe with excessive force. Use with excessive force could result in injury to the patient. |
| ! | Scan for minimum time necessary at the lowest possible acoustic output. Acoustic output may affect the patient's internal tissues. For details about the acoustic output, please refer to the documentation supplied with the ultrasound diagnostic instrument. |
| ⊘ | Do not touch the connector terminal pin of the probe. Electrostatic discharge may result in malfunction of the probe. |
| ⊘ | Do not touch the probe connector of the ultrasound diagnostic instrument and the patient at the same time. It can cause electric shock to the patient. |
| ⊘ | When it is used in conjunction with a high-frequency surgical instrument, do not place the probe and operator's hands in the path of high-frequency current. The probe could be damaged, and the patient, examiner or operator could receive burns. Operate this instrument with caution, paying attention to the positions of the counter electrode plates and the connecting cord relative to the probe. |

4-3. Pulling out the probe

Gently pull out the probe from the trocar.

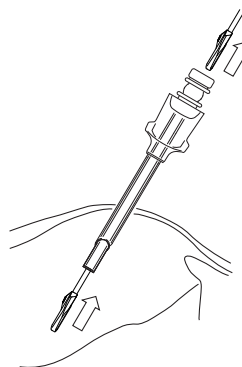

| | |
|------------------|--|
| ⚠ Warning | |
| ! | When removing the probe, pull out the cable slowly and carefully without bending or twisting. Do not remove the probe forcibly, as this may cause injury to a patient. If the probe is not removed smoothly, operate it carefully and confirm endoscopically that there is no abnormality. |
| ! | Clean and sterilize the probe if blood is adhered to the probe, otherwise there is a risk of infection |

This page intentionally left blank

This page intentionally left blank

■ Manufacturer



Hitachi, Ltd.

2-16-1, Higashi-Ueno, Taito-ku, Tokyo, 110-0015, Japan

■ Contact

+81-3-6284-3668

<http://www.hitachi.com/businesses/healthcare/index.html>

Overseas Offices:

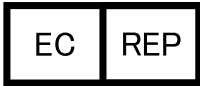

Hitachi Medical Systems GmbH

Otto-von-Guericke-Ring 3 D-65205 Wiesbaden, Germany

EU Importer: Hitachi Medical Systems Europe Holding AG

Address: Sumpfstrasse 13 CH-6300 Zug, Switzerland

US Importer: Hitachi Healthcare Americas Corporation

Address: 1959 Summit Commerce Park, Twinsburg, Ohio 44087

Distributor