

## C41V Probe

### INSTRUCTION MANUAL

Notes for operators and responsible maintenance personnel

- ★ Please read through this Instruction Manual carefully prior to use.
- ★ Keep this Instruction Manual together with the system with care to make it available anytime.

 **Hitachi, Ltd.**  
Tokyo, Japan

Q1E-EP1363-6

Manufacturer:



Hitachi, Ltd.

2-16-1, Higashi-Ueno, Taito-ku, Tokyo, 110-0015, Japan

+81-3-6284-3668

<http://www.hitachi.com/businesses/healthcare/index.html>

European

Representative:



Hitachi Medical Systems GmbH

Otto-von-Guericke-Ring 3 D-65205 Wiesbaden,  
Germany

EU Importer:

Hitachi Medical Systems Europe Holding AG

Address:

Sumpfstrasse 13 CH-6300 Zug, Switzerland

Local Distributor:

## About this manual

This instruction manual contains safety precautions, the inspection, the operation procedure and the reprocessing procedure of C41V Probe. Please read this manual thoroughly to ensure the safety operation. If you have any questions concerning the operation of the probe, please contact a service support.

The following conventions are used throughout the manual to denote information of special emphasis.







**WARNING:** "Warning" indicates the presence of a hazard which may result in severe personal injury, substantial property damage, or death if the warning is ignored.

**CAUTION:** "Caution" indicates the presence of a hazard which will or can cause minor personal injury or property damage if the caution is ignored.

**NOTICE:** "Notice" indicates information of installation, operation, or maintenance, which is important, but not hazard related.

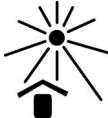







Graphical Symbols for Use in Labeling of Hitachi Ultrasound Probes

Some graphical symbols that are used in labeling of Hitachi Ultrasound Probes are compliant with EN980:2008 standard. Refer to the following table about the meanings of them.

Explanation of Symbol	Symbol	Descriptive Content
Manufacturer Company Name and Address		Hitachi, Ltd. 2-16-1, Higashi-Ueno, Taito-ku, TOKYO, 110-0015, Japan +81-3-6284-3668 <a href="http://www.hitachi.com/businesses/healthcare/index.html">http://www.hitachi.com/businesses/healthcare/index.html</a>
Authorized Representative in The European Community		Hitachi Medical Systems GmbH Otto-von-Guericke-Ring 3 D-65205 Wiesbaden, Germany
Keep away from Sunlight		Store the probe in a cool, dustproof and dark, dry place to avoid high temperature, humidity and direct sunlight.
Contains or presence of natural rubber latex		Contains or presence of natural rubber latex
Do not re-sterilize		Do not re-sterilize
Do not reuse		Do not reuse

Definition of symbol

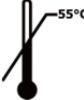
The following symbol is also used for HITACHI Ultrasound Probes.

Location	Symbol	Definition
Probe connector		This instrument complies with Directive 93/42/EEC relating to Medical Device and Directive 2011/65/EU relating to RoHS
Probe connector	<b>IPX7</b>	IPX7 mark See section 1.6.
Probe connector		Type BF APPLIED PART
Probe connector		General warning sign
Probe connector		Warning; dangerous voltage
Probe connector		Caution; Biohazard
Probe connector		Follow the instruction manual to operate this instrument. If not avoided, may result in injury, property damage, or the equipment trouble.
Probe connector		STERRAD sterilization compatibility mark
Probe connector		Upper Limit of Temperature; The probes that are applicable to Ethylene Oxide Gas Sterilization use symbol of "Upper Limit of Temperature: 55 degrees".
Probe connector		Do not waste the instrument as general waste. Comply with a local regulation.
Probe connector	<b>Rx Only</b>	By prescription only. U.S. Federal Law restricts this device to sale on order of a physician only.

## CONTENTS

Page

1. Introduction .....	1
1.1 Features .....	1
1.2 Principles of operation .....	1
1.3 Intended Use .....	2
1.4 Components .....	2
1.5 Accessories (Option) .....	3
1.6 Construction .....	4
2. Inspection before Use .....	5
2.1 Inspection for Appropriate Connection .....	5
2.2 Inspection for Material Surface .....	5
3. Operation Procedure .....	6
3.1 Connection and Settings .....	6
3.2 Use of Sterile Puncture Adapter (EZU-PA5V) .....	8
3.3 Display of Needle Guide Line .....	9
4. Cleaning, Disinfection and Sterilization .....	10
4.1 Point of use (Pre-cleaning) .....	11
4.2 Containment and transportation .....	11
4.3 Manual Cleaning and disinfection .....	12
4.4 Drying .....	13
4.5 Inspection .....	13
4.6 Packaging .....	14
4.7 Sterilization .....	15
4.8 Storage .....	16
5. Maintenance and Safety Inspection .....	17
5.1 Daily Inspection .....	17
5.2 Storage .....	17
6. Safety Precautions .....	18
7. Specifications .....	19
7.1 Probe .....	19
7.2 Sterile Puncture Adapter EZU-PA5V .....	20
7.3 Suppliers List .....	21
8. Disposal of the probe .....	21

## 1. Introduction

### 1.1 Features

C41V Probe is a Convex Array Probe.

The acoustic output of this probe when connected to ultrasound diagnostic scanner was measured according to the IEC60601-2-37 standard. The table of measured acoustic output data is contained in the operational manual of each ultrasound diagnostic scanner. This probe is categorized in class IIa according to Directive 93/42/EEC.

According to IEC60601-1 the probe is classified as type BF.

### 1.2 Principles of operation

This probe and the ultrasound diagnostic scanner enable image diagnosis using ultrasonic waves. This system operates under the principles described below.

- 1) When an electric pulse signal is applied from the transmitter to the transducer of the probe, the transducer converts electric signals into mechanical vibration energy for emitting pulse-shaped ultrasonic waves into the body part, liquid or other medium contacting the transducer.
- 2) The emitted ultrasonic waves are reflected by boundaries with different acoustic characteristics (acoustic impedance) within the body.
- 3) The transducer is also used to receive reflected ultrasonic waves. The transducer vibrates mechanically due to the received ultrasonic waves and converts mechanical vibrations into electric energy. Electric signals are converted to shades of brightness by brightness modulation to obtain an image.

### 1.3 Intended Use

C41V Probe is designed for observation and diagnosis of the following regions mainly by connecting with the HITACHI ultrasound diagnostic scanner.

- General OB/GYN organs
- Biopsy (with a Sterile Puncture Adapter)
- Transvaginal/Transrectal

#### **WARNING**

Never use the probe for following regions.

- 1) The heart (Do not contact directly.)
- 2) The eyeball

### 1.4 Components

Components of C41V Probe are as follows:

- 1) Probe ..... 1 piece
- 2) Instruction Manual ..... 1 copy

#### **CAUTION**

Sterilization has not been made to the probe shipped from the factory. Prior to use of the probe, be sure to clean, disinfect and sterilize it.



## 1.5 Accessories (Option)

### 1.5.1 Sterile Puncture Adapter EZU-PA5V (Disposable)



Attachment for ultrasound guided transvaginal or transrectal biopsy and aspiration of organs, cyst and tumor. The size of



available needle is 16 to 19G. Application requires special care. Sterile Puncture Adapter EZU-PA5V is as follows:

Component	Model	Note
Sterile Puncture Adapter	EZU-PA5V	24 pcs

NOTE: If you need Sterile Puncture Adapters, please contact a service support.

### CAUTION

A well-trained physician only should perform a biopsy.

### 1.5.2 Mechanical Compression Unit for Elastography EZU-TEMC1 and balloon set for Elastography EZU-TEBL2

This mechanical compression unit is used for tissue elasticity imaging, by using the balloon attached to the probe that is connected to a Hitachi's digital ultrasound scanner system and electronic scanning ultrasound tomography system.

Please refer to the instruction manual of option about the method of handling, cleaning and disinfection of EZU-TEMC1 and EZU-TEBL2.

### 1.5.3 Condom or Protection Sleeve for Single Use (Disposable)



To protect the probe against contamination, using only lubrication free condom or protective tube sleeve which is dry type is recommended.



Lubrication may cause a deterioration of the probe surface. And latex rubber may create allergic reactions, use of non-allergic condom or sleeve is strongly recommended.

Take care for the handling of used condom or protection sleeve.

## 1.6 Construction

The external view of C41V Probe is shown in Fig. 1.

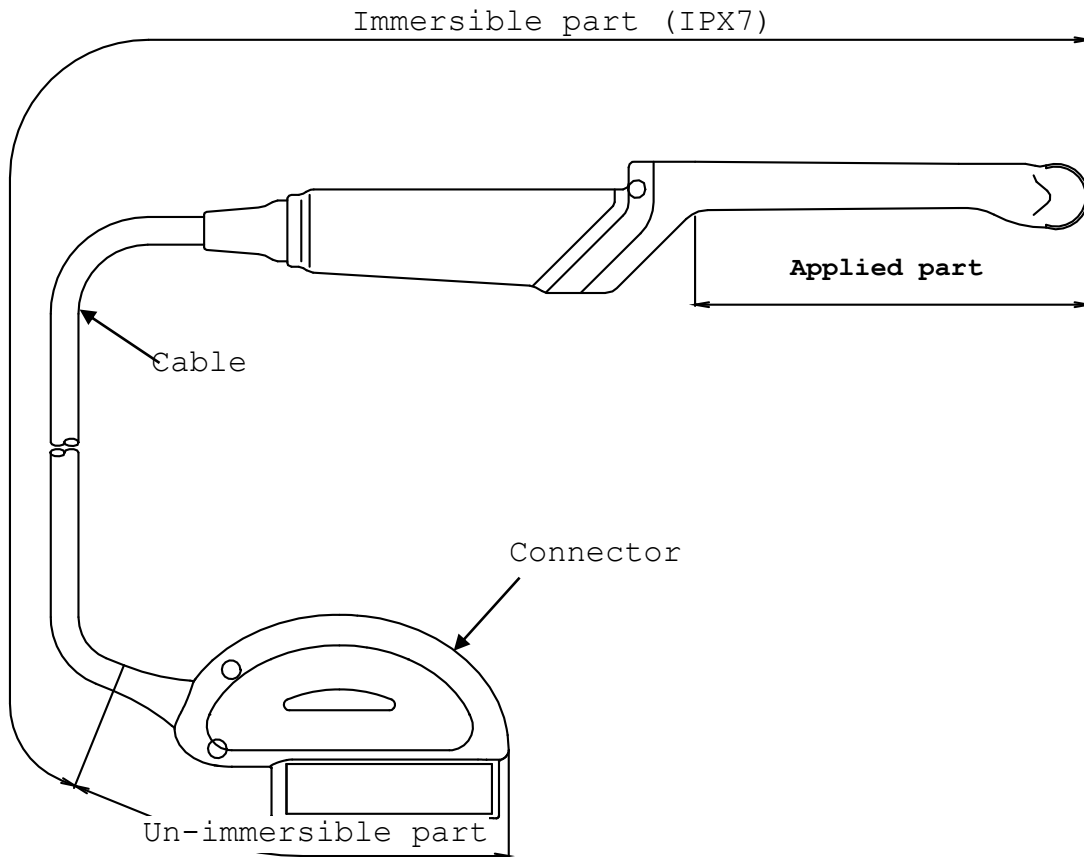

**Immersible part:** This part can be immersed in disinfectant solution and also can be cleaned by water.

**Un-immersible part:** This part should not be immersed in disinfectant solution and also cannot be cleaned by water.

Fig. 1 External view

## 2. Inspection before Use

Prior to use, the probe and accessories must be carefully inspected that they are appropriate for use. If you find any damage, do not use them and contact a service support immediately.

### 2.1 Inspection for Appropriate Connection

- 1) Confirm that the system is correctly operating. Refer to the instruction manual for the ultrasound diagnostic scanner.
- 2) Do not attach or connect unauthorized devices or instruments on the probe, such as unauthorized biopsy attachments.
- 3) Confirm that the Sterile Puncture Adapter and software version and then settings of the scanner are appropriate for the probe. Attach the Sterile Puncture Adapter on the probe. Set the ultrasound diagnostic scanner to display the "Needle guide line". (Refer to the operation manual for the ultrasound diagnostic scanner.) Keep the probe head in the water and insert a puncture needle in the Sterile Puncture Adapter. Then, confirm that the needle is inserted smoothly and the echo of the needle is displayed on the dot line "Needle guide line" on the monitor.

### 2.2 Inspection for Material Surface

- 1) Visually inspect the surface of the probe head, housing and cable for any crack, scratch or denaturalization.
- 2) Visually inspect the envelope of the Sterile Puncture Adapter for any break, deformation, crack or denaturalization. If you find any damage, do not use the Sterile Puncture Adapter.

### 3. Operation Procedure

#### 3.1 Connection and Settings

- 1) Confirm that the probe is cleaned, disinfected and sterilized.
- 2) It is recommended to use a disposable probe cover for preventing a patient from infection and the probe cover should be made of allergy free material to avoid allergic reaction.
- 3) Connect the probe to the ultrasound diagnostic scanner and operate the scanner and adjust the image according to the instructions given in the operation manual for the ultrasound diagnostic scanner.
- 4) Put proper quantity of sterilized acoustic jelly on the probe head as a couplant. (See Fig. 2.)

Sterilized acoustic jelly

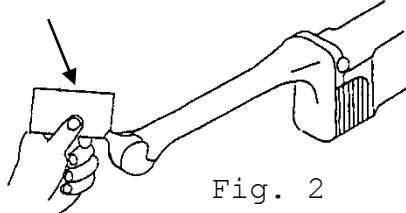
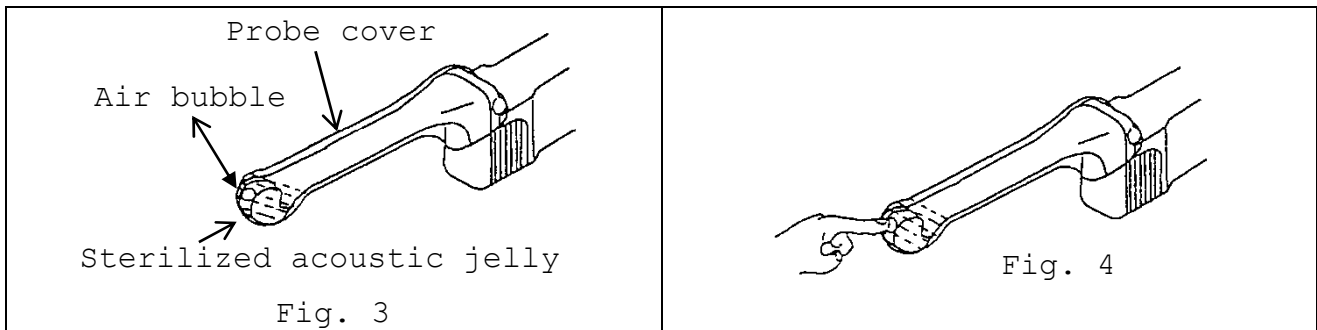

Fig. 2

- 5) Put a probe cover on the probe and draw the probe cover until the end of the probe shaft. To avoid air bubbles, be careful to press the probe cover gently against probe head and to keep jelly on the probe head. If air bubbles appear on the probe head, remove air bubbles by pushing jelly with finger. (See Fig. 3 and Fig. 4.)



#### **! WARNING**



Be careful with a probe cover made out of latex. The latex may cause such allergic reactions as itching, rubor, urticaria, swelling, fever, anhelation, wheezing, and depression of blood pressure, shock and so on.

If your patient shows any of the above mentioned symptoms during the operation, stop the use of protective sleeve immediately and take an appropriate treatment to the patient.

- 6) Fix jelly on the top of the probe with sterile adhesive tape. (See Fig. 5.)

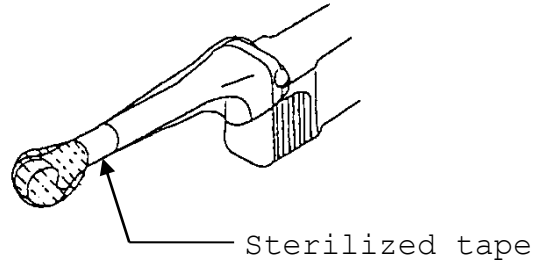

Fig. 5

- 7) Insert the probe gently and adjust the probe's position for a clear view of the desired image. By turning or tilting the probe, a "turn around" imaging is possible. If the image is insufficient, use sterile saline solution. This solution improves the contact between probe and organ.
- 8) After using the probe, clean, disinfect and sterilize the probe immediately.
- 9) Store the probe in the environment indicated in "5 Maintenance and Safety Inspection".

### 3.2 Use of Sterile Puncture Adapter (EZU-PA5V)

The process of attaching the Sterile Puncture Adapter (EZU-PA5V) to the probe is as follows. If the Sterile Puncture Adapter is used, careful handling is necessary to avoid damage of the probe cover. During open or minimal invasive surgery, use the protection sleeve to cover probe and cable.

- 1) Attach a sterile probe cover to the probe. (See "3.1 Connection and Settings")
- 2) Put the picks of the Sterile Puncture Adapter to the grooves on the tip of the probe. (See Fig. 6.)

Sterile Puncture Adapter (EZU-PA5V)

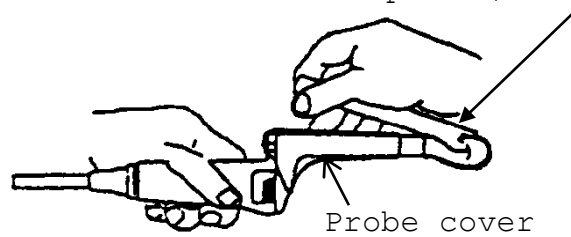

Fig. 6

- 3) Push the other end of the Sterile Puncture Adapter until fix the dents of the Sterile Puncture Adapter to the projection on the probe. (See Fig. 7.)

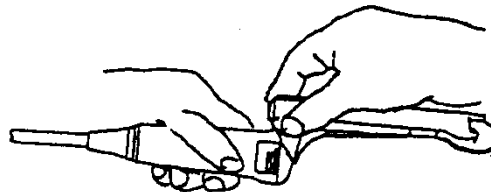

Fig. 7

### 3.3 Display of Needle Guide Line

When puncture is to be conducted, the needle guideline can be displayed by dot marks. Operation procedure for displaying the needle guideline on the ultrasound diagnostic scanner must be referred to the part of "Needle guide line" in the manual of the connected the ultrasound diagnostic scanner.

NOTE: The needle guide line will be displayed to provide a visual guide to the direction of the puncture needle pathway. Be sure to check the actual location of the needle on the ultrasound image when performing the puncture operation.

#### ⚠ CAUTION

The needle guide line can be displayed with this probe; however, some image display may not be appropriate for puncture procedure according to the location of observation field-of-view. Use observation field-of-view that is appropriately according to the location of puncture.

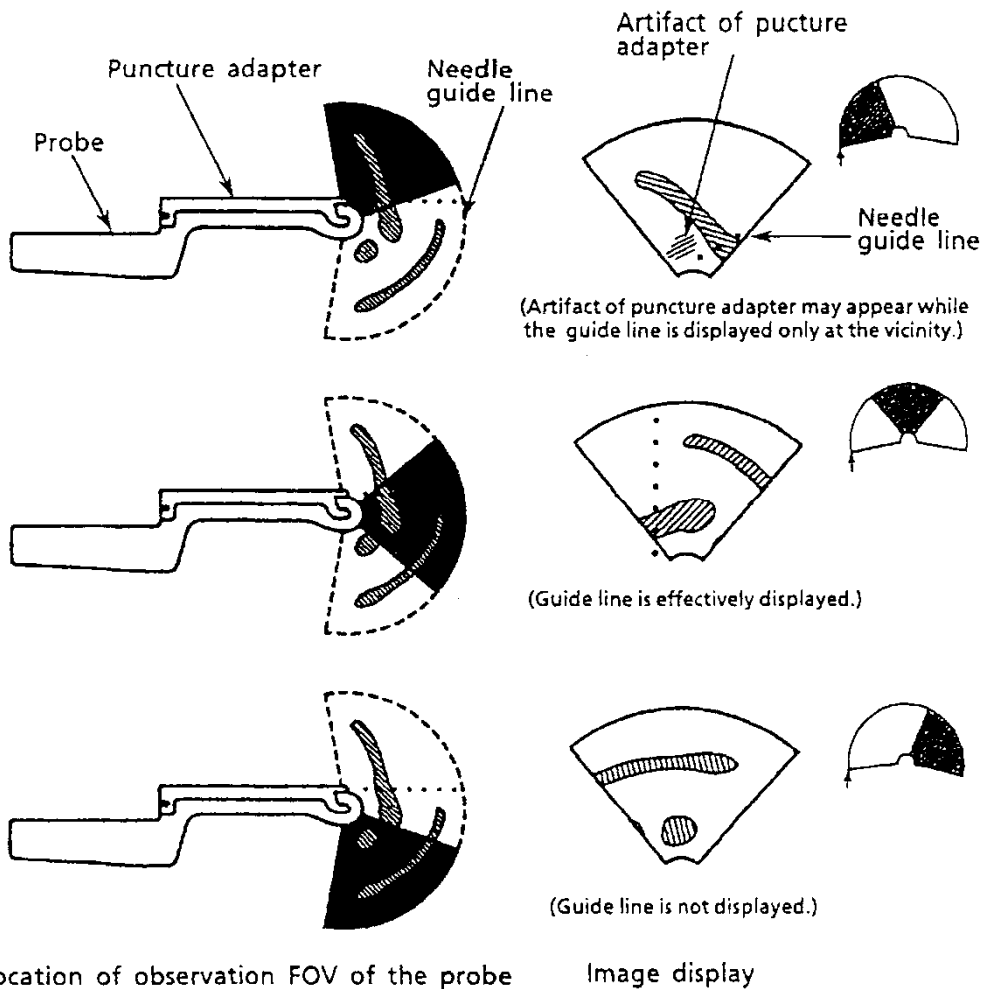

#### 4. Cleaning, Disinfection and Sterilization



The probe and accessory must be reprocessed after each use. Refer to the reprocessing instruction in this chapter.

WARNINGS	<ul style="list-style-type: none"> <li>- The probe is delivered unsterile. Prior to the first use, reprocess the probe.</li> <li>- Temperature should not exceed 60°C during reprocessing.</li> <li>- Probe connector is not water resistant.</li> </ul>
Limitations on reprocessing	The probe is not completely submersible. The immersible part is shown in Fig.1. The un-immersible part should be disinfected by wipe disinfection.
Transportation before using	The probe should be packed in a sterile pouch or container to transport from Central Sterile Supply Department (CSSD) to an operating room. Be careful not to damage the sterile pouch or container during transportation.

#### Levels of reprocessing requirements:

Depending on the application of the product and with regard to risk evaluation, the user has to classify the medical device according to the current Medical Device Directive for processing of medical devices as uncritical, semi-critical or critical. Supporting information concerning this topic is listed in the table below. The user is responsible for correct classification of the medical device.

Classification	Definition	Processing
uncritical	Application part only contacts intact and uninjured skin	Cleaning Disinfection
semicritical	Application part contacts mucosa (intracavitary application)	Cleaning Disinfection (Disinfectant with virucidal effect)
critical	Application part contacts intracorporeal tissue directly (operative application)	Cleaning Disinfection (Disinfectant with virucidal effect - minimum) Sterilization

According to the intended use, C41V probe is classified as semicritical.



The flowchart of the reprocessing process of this probe is as follows.

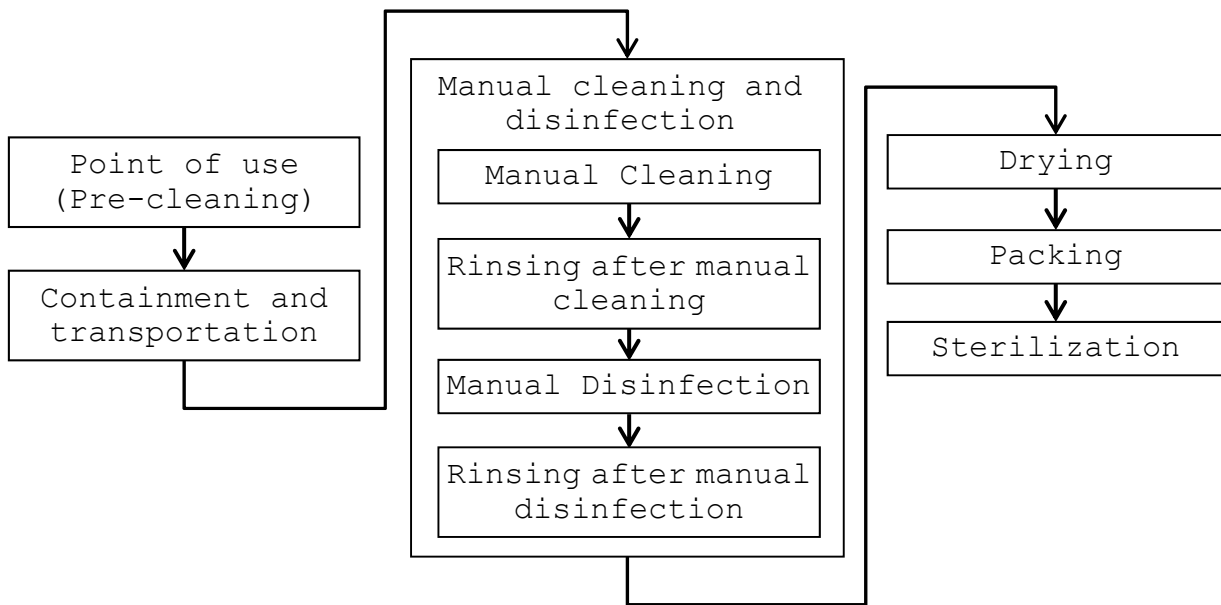

#### 4.1 Point of use (Pre-cleaning)

Pre-cleaning should be done immediately after each use. The procedure is as follows:

- 1) Remove the protective cover.
- 2) Clean the probe of all patient's blood or fluid with running tap water until the surface of the probe looks visually clean.
- 3) Wipe the whole surface of the probe with gauze pad and remove superficial visible impurities and leavings of ultrasound jelly

#### 4.2 Containment and transportation

Putting the contaminated equipment into exclusive shock and damage proof container for transportation is recommended. It is recommended that instruments are reprocessed as soon as possible and not later than 4 hours after usage.

### 4.3 Manual Cleaning and disinfection

Prepare following items before manual cleaning and disinfection:

- a) Detergent: Cidezyme (Johnson & Johnson, #2258) or another cleaning agent with approved material compatibility for this medical device
- b) Disinfectant: Cidex OPA (Johnson & Johnson, # 20391) or another disinfectant with approved material compatibility for this medical device
- c) Two tanks, one for cleaning and one for disinfection - optional:  
1 additional tank for rinsing with deionized/tap water (sufficient size for immersion of the immersible part of the probe at full length)
- d) Soft, fluff free cloth or single use towel
- e) Personal protective equipment (gloves, water repellent protective skirt, face protection mask or protective glasses, see also instructions of the manufacturer for the detergent and the disinfectant)

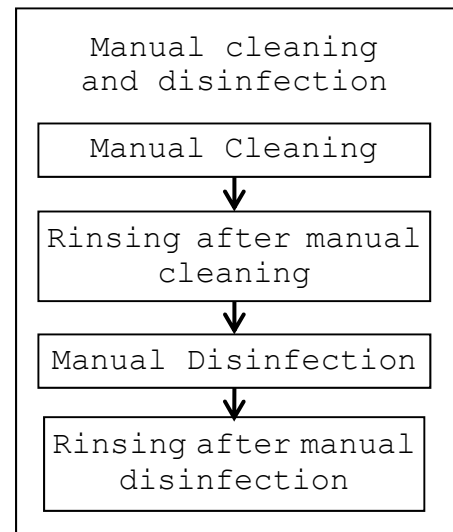

#### Manual Cleaning:

Prepare the detergent solution in a tank with cold water (please follow the instructions of the detergent manufacturer regarding application, dilution and contact time).

- 1) The temperature of the detergent solution should be between 15-30°C, concentration is 1.6%. Please note the minimum contact time of the detergent in the manufacturer's instruction. If a differing detergent is used, please also note the approved material compatibility for the medical device.
- 2) Immerse the immersible part of the probe without connector into the diluted detergent solution (see Fig.8). Wipe the immersible part of the probe under the surface of the detergent solution with a soft cloth to remove all visible soil. Be sure that all grooves of the probe are implemented during the cleaning process.
- 3) The immersible part of the probe should be left in the detergent solution according to the specified contact time of the detergent manufacturer.
- 4) Wipe the un-immersible parts of the probe with a soft cloth dipped with the detergent solution.
- 5) Rinse the probe with running tap water for 1 minute. (alternatively: immerse the immersible part of the probe in a tray filled with deionized water/tap water (see Fig.8) for 5 min.)
- 6) Visually check the outer surface of the probe for cleanness. If necessary, use magnifying glass for visually check. If there is still soil visible, repeat all above steps.

### Manual disinfection:

- 1) Prepare the disinfectant solution in a tank with cold water (please follow the instructions of the disinfectant manufacturer regarding application, concentration, microbiological efficiency, service life and contact time).
- 2) Confirm the concentration of the disinfectant before immersing the probe. Although Cidex<sup>®</sup> OPA does not need to be diluted, it is recommended to use test strips to verify the concentration. The test strips can indicate whether or not the concentration is above the Minimum Effective Concentration (MEC). Please also note the expiration date of the test stripes. Temperature of disinfectant solution should be minimum 20°C. The minimum contact time is 5 minutes. If a different disinfectant is used, follow the manufacturer's instructions. Please also consider the material compatibility for the medical device.
- 3) Immerse the immersible part of the probe into the disinfectant (see Fig.8). Set a clock to insure the recommended contact time which is 5 minutes.
- 4) Rinse the immersible part of the probe with deionized water for 1 minute. (alternatively: immerse the immersible part of the probe in a tray filled with deionized water (see Fig.8) for 5 min.)
- 5) Visually check the outer surface of the probe for leavings of the disinfectant. If necessary, repeat the rinsing.

Water, Detergent  
or Disinfectant

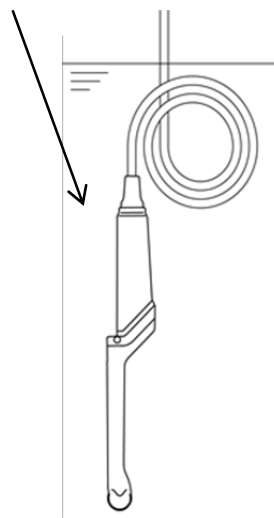

Fig.8 Immersion of the probe

#### 4.4 Drying

- 1) Wipe the probe with a single-use, fluff-free wipe or towel to remove moisture from the surface of the probe.
- 2) Dry the probe naturally in an ambient temperature between 15-30°C for a minimum of 4 hours. Alternatively the equipment can be dried using a drying heater at a temperature of less than 60°C.

Drying

#### 4.5 Inspection

Inspect the equipment for any damage such as crack, scratch or deformation. Do not use it if any damage is found.

#### 4.6 Packaging

Pack the probe in a sterile barrier such as Polypropylene fleece or transparent package made from Polyethylene film and Tyvek<sup>®</sup>, and then place it into a tray. The tray should be also covered with a sterile barrier.

Additionally the probe can be placed on plastic mesh wires supplied for plasma sterilization and then packed as mentioned above.

The probe can be packed in a simple or double packing.

Please note that the size of a sterile barrier should be large enough to be able to pack the equipment leaving sufficient space to seal it completely.

A sterile barrier should be sealed by an appropriate sealing machine and it is important to confirm that the package is sealed completely. If the sealing is not complete, pack and reseal again.

## 4.7 Sterilization

The probe can be sterilized using either ethylen oxide gas (EtO) sterilization or plasma sterilization (see table below).

Follow the manufacturer's instructions of the sterilizer regarding usage, temperature and sterilization-time.

The sterilization method and operating conditions are as follows.

➤ ETO Gas Sterilizer, closed system

Parameter	Specification
Preconditioning	None
Conditioning in Chamber (Dwell)	Temperature: 122.0 - 131.0 °F (equivalent of 50 - 55 °C) Humidity: 40 - 90 % RH Prevacuum: 8 - 26 kPa Time: 30 - 45 minutes
Exposure	Temperature: 122.0 - 131.0 °F (equivalent of 50 - 55 °C) Sterilant gas: 10 % EO / 90 % HCFC Excess pressure: 162 - 200 kPa Exposure time: 120 - 125 min (full cycle)
Post-vacuum	8 - 26 kPa, 2 times
Aeration	Temperature: 50 - 55 °C Time: min. 11 hours

➤ Plasma sterilization

Sterilization Method	Condition
Plasma Sterilization: STERRAD® 50, 100S or 200 (*)	Short Cycle
Plasma Sterilization: Sterrad® NX or 100NX (*)	Standard cycle

\* STERRAD® systems are manufactured by "Johnson & Johnson"

⚠ WARNING ⚠

- 1) Before performing sterilization, check that the operation data of sterilizer are in conjunction with min. and max. data applicable for the probe.
- 2) Do not sterilize the probe by Steam Autoclaving. If you autoclave it, it suffers serious damage and will not be functional.

The packaging before sterilization is as follows.

- 1) Put the probe into TYVEK pouch.

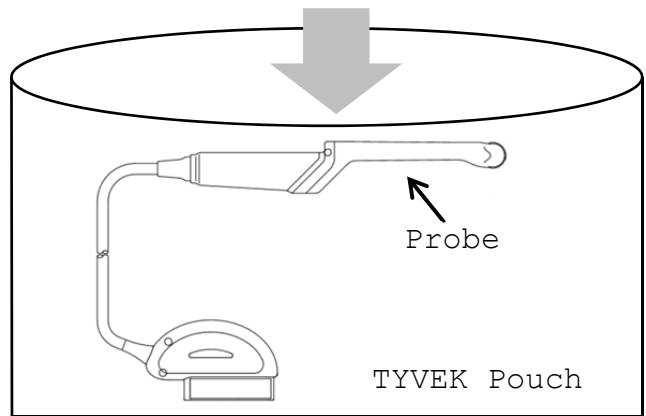

Fig. 9 Packaging in the pouch

- 2) Seal the TYVEK Pouch using a heat sealer. Ensure that the seal is complete.

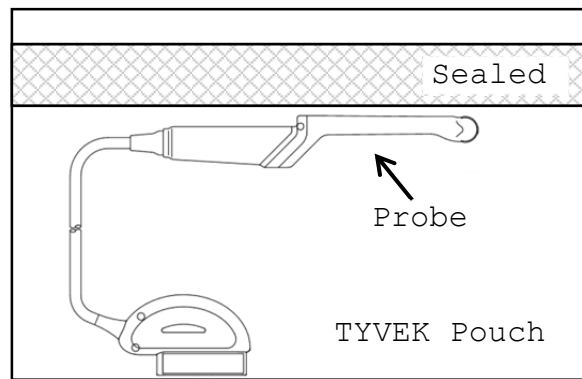

Fig. 10 Sealing

- 3) Put the sealed pouch into a tray or plastic mesh wire for sterilization.

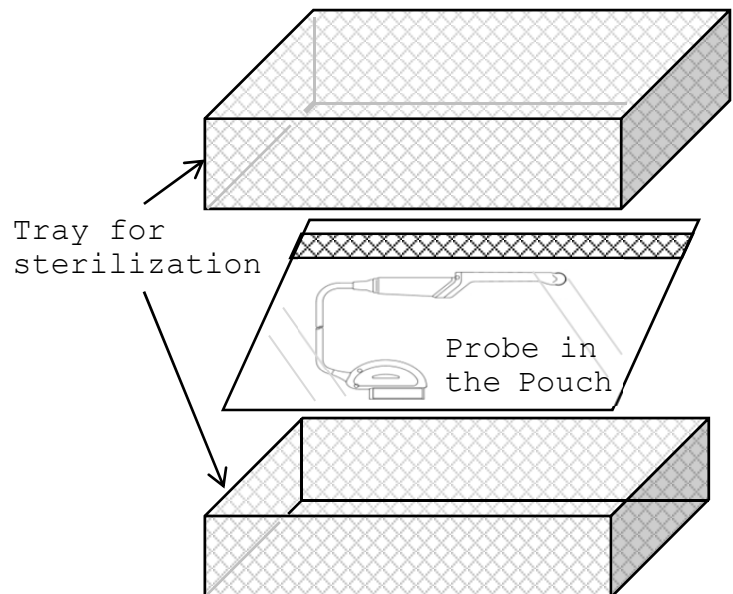

Fig.11 Packaging in a tray

#### 4.8 Storage



Store the equipment in a cool, dustproof, dry, and dark space to avoid high temperature, humidity and direct sunlight. Limitations for the time for sterilized equipment belong to package.

## 5. Maintenance and Safety Inspection

### 5.1 Daily Inspection

Visually inspect the surface of the probe head, housing, cable and connector for any crack, scratch or denaturalization. If you find any damage, do not use the probe and contact a service support immediately.

### 5.2 Storage

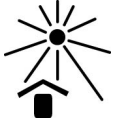

After using the probe, it should be cleaned and disinfected and sterilized following "4. Cleaning, disinfection and Sterilization" immediately. Then store it in a cool and dark place avoid high temperature, humidity and direct sunlight.

## 6. Safety Precautions

### **WARNING**

- 1) Never use the probe if the probe head, shaft or cable are cracked or damaged.
- 2) When use C41V Probe for biopsy purpose, use Sterile Puncture Adapter EZU-PA5V (Option) certainly.
- 3) Never use the Sterile Puncture Adapter if the adapter is deformed, cracked or damaged.
- 4) Do not use the latex probe cover for latex sensitive patients. The probe cover, which contains latex, may cause allergic reactions as itching, rubor, urticaria, swelling, fever, anhelation, wheezing and depression of blood pressure, shock and so on.
- 5) The ultrasound gel attached to the ultrasound scanner as one of accessories is not sterile. So never use it with C41V Probe.

### **CAUTION**

- 1) By OB/GYN applications of the probe during surgical or minimal-invasive procedures, take care that electro cautery devices are out of range. In case of using defibrillation, take the probe out or away from the body.
- 2) Keep the acoustic power low and minimize the ultrasound exposure time for the examination of an early pregnancy.
- 3) Do not expose the connector to water or other liquids. The connector is not waterproof.
- 4) Do not hit or drop the probe. The probe is easily damaged by mechanical shock.
- 5) Do not use detergents and disinfectants other than listed in "7.3 Suppliers list".
- 6) Use a sterile probe cover to avoid staining or damaging the acoustic lens.
- 7) Clean, disinfect and sterilize the probe before the first use as it is not sterilized in the factory.
- 8) Use only the soft cloth or tissue to clean the acoustic lens.
- 9) Only a well-trained physician should perform a biopsy.
- 10) Do not attach unapproved devices to the probe.



## 7. Specifications

### 7.1 Probe

Type:	C41V Probe
Acoustic working frequency:	6.5MHz
Technology:	Convex Array Probe
Dimensions:	See Fig. 12
Weight:	Approx.0.60kg (Including cable and connector)
Probe materials:	Bio-compatible allergy free components
Acoustic output:	According to IEC 60601-2-37 (See Main Unit manual.)
Applicable system:	Depending on production and upgrade status. For detailed information contact a service support.
Classification:	MDD classification IIa.
Cleaning:	Applicable detergents are listed in the suppliers list
Disinfection:	Applicable disinfectants are listed in the suppliers list
Sterilization:	ETO gas sterilization or Plasma sterilization
Operating conditions:	
Ambient temperature:	+10 - +35°C
Contact surface temperature (Temperature of examinee):	max. 42°C
Relative humidity:	30 - 85%
Storage conditions:	
Temperature:	-10 - +55°C
Relative humidity:	10 - 95% (Subject to no condensation)

## 7.2 Sterile Puncture Adapter EZU-PA5V

Type: EZU-PA5V  
External view: See Fig. 13  
Acceptable needle gauge: 16G to 19G  
Materials: Bio-compatible allergy free components  
Classification: MDD classification IIa  
Package: 24 Sterile Puncture Adapters for single use  
Sterilization method: Sterilized with gamma irradiation

### Operating conditions:

Temperature: -10 - +40°C

### Storage conditions:

Temperature: -10 - +40°C

### 7.3 Suppliers List

The products listed below are seriously tested and approved for use with C41V Probe.

Product name	manufacturer	purpose
Cidezyme®	Johnson & Johnson	Enzymatic detergent
STERANIOS 2%	ANIOS	Disinfectant
ANIOXYDE1000	ANIOS	Disinfectant
CIDEX	Johnson & Johnson	Disinfectant
CIDEX® plus™ 28	Johnson & Johnson	Disinfectant
CIDEX® OPA	Johnson & Johnson	Disinfectant
HYAMINE SOLUTION	RICCA CHEMICAL COMPANY	Disinfectant
STERIHYDE®	Maruishi Pharmaceutical	Disinfectant/sterilize
WAVICIDE-01	Mediacal Chemical Corp	Disinfectant/sterilize

Please contact your local distributor for a current version of the "Disinfectant/Sterilization Method Compatibility for Ultrasound Probe and Accessory List"

### 8. Disposal of the probe

Recycle or dispose this equipment properly in compliance with the Waste Management and Public Cleansing Law.

#### ⚠ CAUTION

Before disposing the equipment, disinfect or take other infection-prevention measures. Disposal of the equipment without taking the proper preventative measures can lead to infection.

Waste Electrical and Electronic Equipment (WEEE) Directive  
 The illustration on the right is required by the EU WEEE Directive to appear on all electrical and electronic equipment. For proper disposal of this product in an EU nation, contact an EU office or agency and observe appropriate local and national regulations and laws.



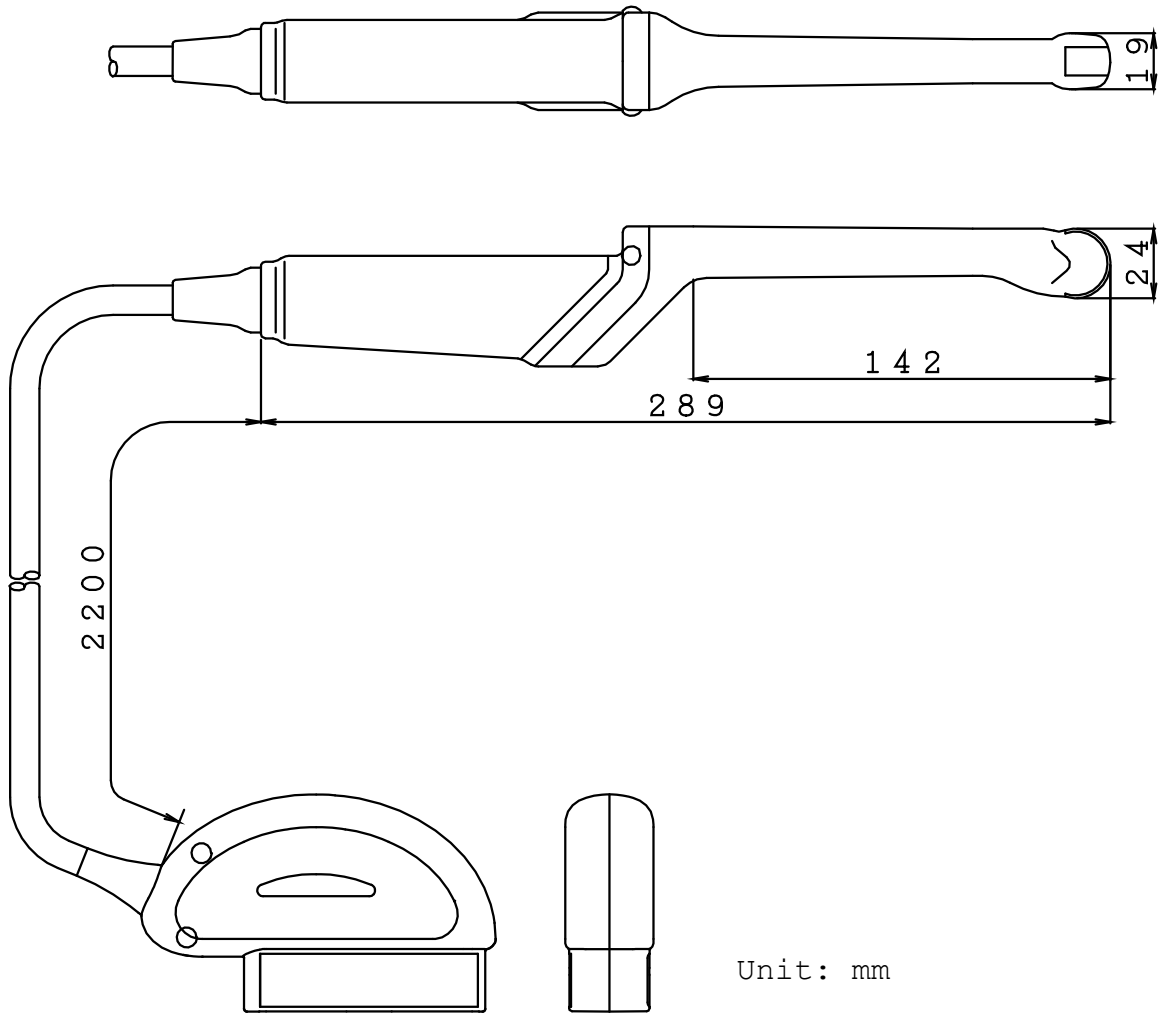

Unit: mm

Fig. 12 External view of C41V Probe

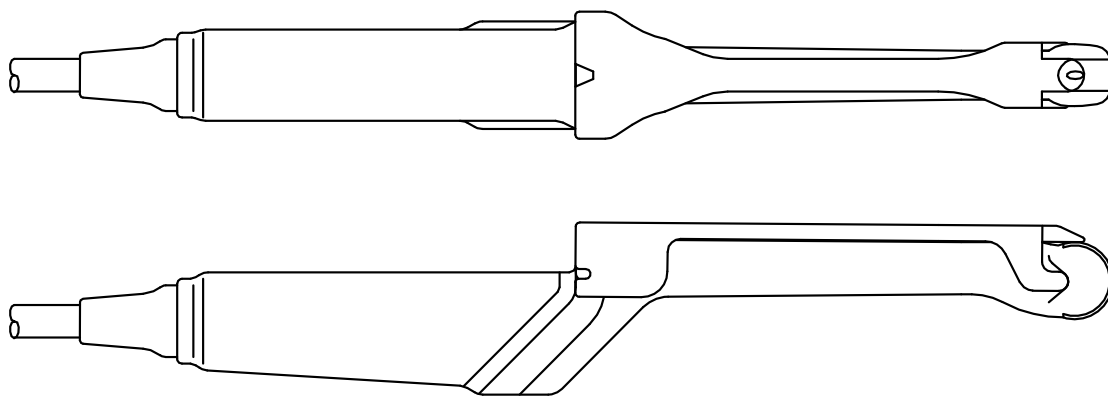

Fig. 13 External view of C41V Probe with Sterile Puncture Adapter (EZU-PA5V)