

C252 Probe  
Instruction Manual  
Specification  
MN1-6297 Rev. 3

*Notes for operators and responsible maintenance personnel*

- ★ *Please read through this Instruction Manual as well as the separate Instruction Manual “Safety (MN1-5982)” and “Cleaning, Disinfection and Sterilization (MN1-5998)” carefully prior to use.*
- ★ *Keep this Instruction Manual together with the ultrasound diagnostic instrument for any future reference.*



© Hitachi, Ltd. 2016, 2017. All rights reserved.



## Introduction

This is the instruction manual for C252 probe. The probe is available by connecting to Hitachi's ultrasound diagnostic instrument and can be mainly used for observation of general abdominal organs.

Prior to use, read this manual as well as the separate instruction manual "Safety" in which information for safe use is provided.

The probe bears the CE mark but the mark is valid only when the probe is connected to the ultrasound diagnostic instrument bearing the CE mark.

### Symbols used in this document

Safety information is classified into Danger, Warning, Caution, and Note according to the level of hazard. Those terms are used in safety information provided to prevent hazards and injuries to the operator or patient.

#### Danger

Indicates an imminently hazardous situation which, if not avoided, will result in death or serious injury to the operator or patient.

#### Warning

Indicates a potentially hazardous situation which, if not avoided, could result in death or serious injury to the operator or patient.

#### Caution

Indicates a potentially hazardous situation which, if not avoided, may result in minor or moderate injury to the operator or patient, or property damage only.

#### Note

Indicates a strong request concerning an item that must be observed in order to prevent damage or deterioration of the equipment and also to ensure that it is used efficiently.

The type of safety information is indicated by the symbols below.



This symbol means that attention is required.



This symbol means that the described action is prohibited.



This symbol means that the described action is mandatory.

# CONTENTS

1. General Information.....	1
1-1. Intended use.....	1
1-2. Classification of ME equipment.....	1
1-3. Standard components .....	1
1-4. Options.....	2
2. Specifications and Parts name.....	3
2-1. Specifications.....	3
2-2. Name of each parts.....	4
3. Preparations before use .....	5
3-1. Visual check .....	5
3-2. Confirmation of cleaning, disinfection and sterilization.....	5
3-3. Operation check.....	5
4. Operation.....	7
4-1. Operation.....	7
4-2. How to attach/release the magnetic position sensor and the magnetic position sensor attachment.....	8
4-2-1. How to attach the magnetic position sensor.....	8
4-2-2. How to release the magnetic position sensor .....	9

This instruction manual contains 4 pages of front matter and 12 pages of the main content.

1. General Information



General information for the probe is provided below.

1-1. Intended use

This probe is intended to be used by doctors or other qualified operators. The probe is placed on the body for observation of surrounding organs.

Please refer to the ultrasound diagnostic instrument instruction manual used with this probe for the probe intended use information.

Regarding with the connectable instrument, please refer to section 2-1. Specifications of this manual.

 <b>Warning</b>
 Do not use this equipment for other than its intended use. Otherwise it could cause burns or other injuries to the patient or operator.

1-2. Classification of ME equipment

This probe is classified as follows according to IEC60601-1.

Please refer to the section 2-1 for the applied part, the part treated as the applied part, and the range of IPX7.

- Classification based on the degree of protection against electric shock ..... Type BF applied part
- Classification for protection against ingress of liquids ..... IPX7 (Watertight equipment)
- Operation mode..... Continuous operation
- Method of sterilization..... Refer to the separate instruction manual  
 “Cleaning, Disinfection and Sterilization”

1-3. Standard components

The standard components of C252 probe are as follows.

- C252 Probe ..... 1 set
- Storage case ..... 1 set
- Instruction Manual
  - Specification (MN1-6297) ..... 1 copy
  - Safety (MN1-5982) ..... 1 copy
  - Cleaning, Disinfection and Sterilization (MN1-5998) ..... 1 copy

#### 1-4. Options

The following options are available for C252 probe.

- Puncture

Please use the options listed in Table 1 for performing a puncture. Regarding the usage of CIVCO Bracket, please refer to the documentation supplied with the bracket.

Table 1 Options for puncture

Product Name	Product No.
CIVCO Bracket	644-083
CIVCO Probe cover / Biopsy needle guide set	610-608
CIVCO Probe cover / Biopsy needle guide set	610-901

- Real Time Virtual Sonography (RVS)

Please use the option listed in Table 2 for performing RVS. Regarding how to attach/release the attachment, please refer to the section 4-2..

Table 2 Option for RVS

Product Name	Product No.
Magnetic Sensor Attachment	RV-004

## 2. Specifications and Parts name

The specifications and the name of each part are provided below.

### 2-1. Specifications

Application:	Abdomen
Type of patient contact:	Surface
Connectable instruments:	ALOKA LISENDO 880, ALOKA ARIETTA 850
	NOTE: At the time of publication of this manual, the connectable diagnostic ultrasound instrument or instrument software version available with this probe is different for each country, please refer to the instrument instruction manual or contact your local Hitachi representative.
Field of view:	70°
Frequency:	3.0 MHz
Cable length:	2.2 m
Service life:	3 years
Applied part:	Probe tip including ultrasonic radiation part, see the section 2-2
Part treated as Applied part:	Cable up to 1 m length from the probe tip
IPX7 range:	See Figure 1
Measurement accuracy:	Refer to the instruction manual of the ultrasound diagnostic instrument
External dimensions:	See Figure 1

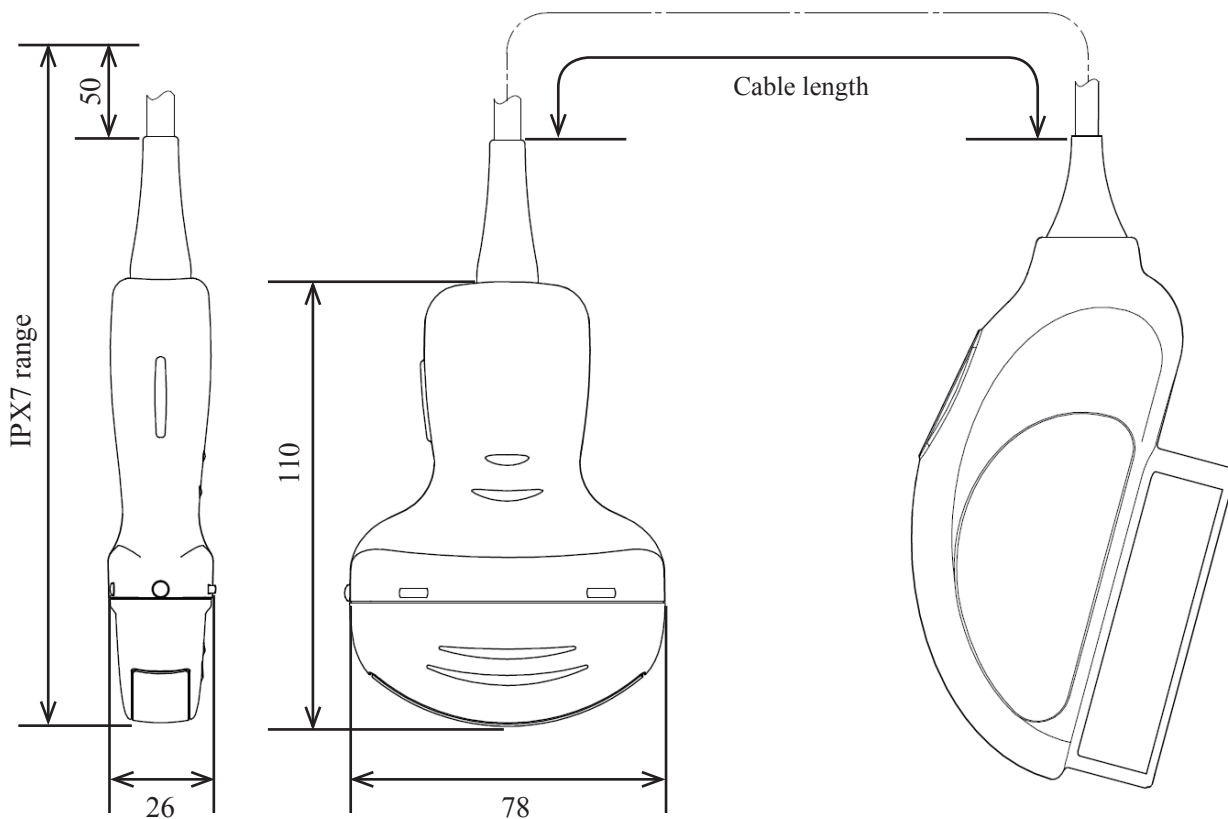

Unit: mm

Remark: The tolerance for the dimensions is  $\pm 10\%$ .

Figure 1 External View

2-2. Name of each parts

The name of each part is shown in Figure 2 and the explanation for each part is listed in Table 3.

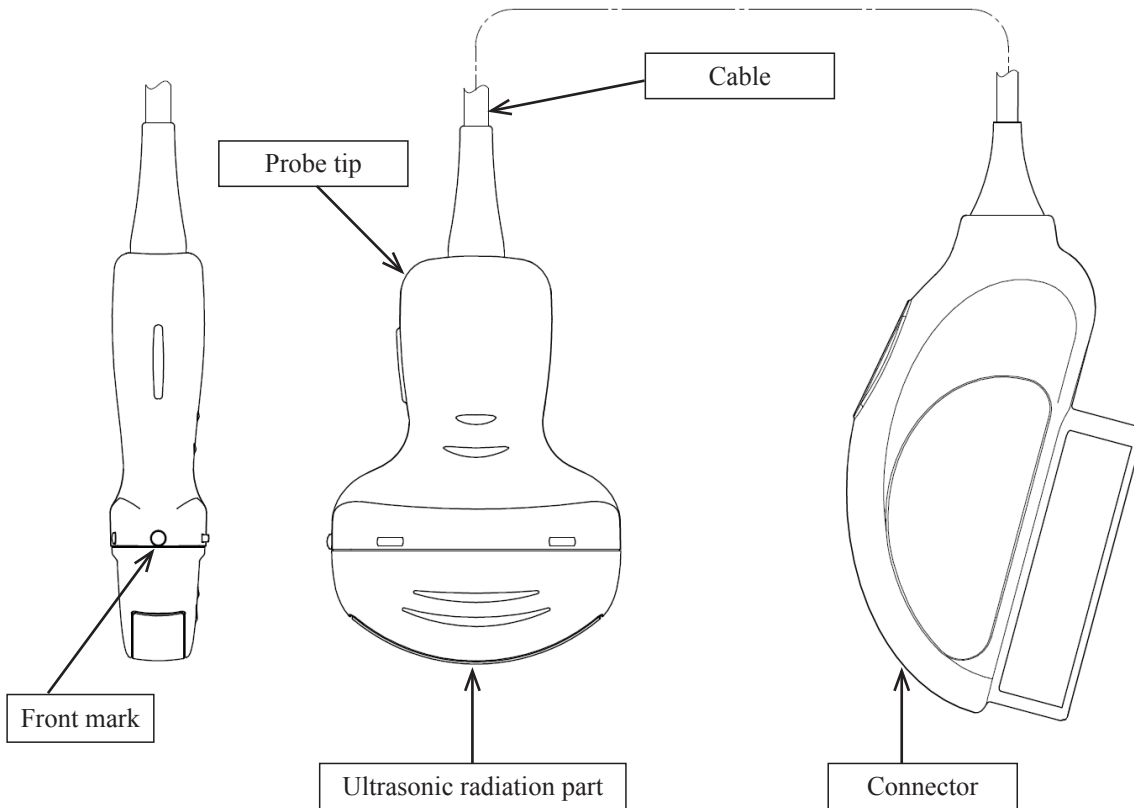

Figure 2 Name of each parts

Table 3 Name of each part and its explanation

Name	Explanation
Ultrasonic radiation part	Ultrasound is radiated from this part. The electronic convex transducer is integrated underneath this part.
Front mark	The side of the front mark corresponds to the side of the orientation mark on the image.
Probe tip	This part is gripped during operation.
Cable	Cable transfers electric input/output signals.
Connector	The connector is the part which is connected to the ultrasound diagnostic instrument.

<p><b>⚠ Caution</b></p>	
<p>⊘ Do not pull, bend, twist, or apply excessive force to the cable. The probe may malfunction due to cable disconnection.</p>	
<p>⊘ Do not subject the ultrasonic radiation part to hard impact. The impact may cause damage to the transducer, and that results in noise or no echo in the image. In most cases, the ultrasonic radiation part itself is not damaged because the part is made of elastic material.</p>	



### 3. Preparations before use

This chapter describes preparations needed to use the probe safely. Please prepare the probe prior to each use by following the instructions below.

#### 3-1. Visual check

Visually check the probe tip, ultrasonic radiation part, cable, and connector.

If any holes, indentations, abrasion, cracks, deformation, looseness, discoloration, or other abnormalities are found, do not use the probe.

Check also the options as necessary.

#### 3-2. Confirmation of cleaning, disinfection and sterilization



Confirm that the probe is certainly cleaned, disinfected and sterilized. The degree of reprocessing depends on the intended use. Please refer to the separate instruction manual “Cleaning, Disinfection and Sterilization“ for cleaning, disinfection and sterilization procedure. Confirm also that options are properly cleaned, disinfected and sterilized.



#### 3-3. Operation check

Connect the probe to the ultrasound diagnostic instrument and check that the displayed scan type and frequency correspond to those of the probe. Check also that there is no abnormality in the image.

Remark: Please refer to the documentation supplied with the ultrasound diagnostic instrument for how to connect the probe and information displayed on the monitor.

If the probe is operated in still air, brightness on the top of the image may be non uniform, but this does not affect the performance of the probe.

 <b>Warning</b>	
	<p>Make preparations prior to each use.</p> <p>The operator and the patient may be injured if the equipment has any abnormality.</p> <p>If any abnormality is found in the equipment, stop using it and contact our office written on the back cover.</p>

 <b>Caution</b>	
	<p>Do not use the probe if the displayed scan type and frequency displayed do not correspond to those of the probe. Incorrect acoustic output can result in burns or other injuries to the patient. Contact our office written on the back cover.</p>







## 4. Operation

This chapter describes the operation of the probe and how to attach/release Magnetic Position Sensor and Magnetic Position Sensor Attachment.

### 4-1. Operation

Place the ultrasonic radiation part of the probe onto the skin surface. An image of the region of interest is displayed on the monitor of the ultrasound diagnostic instrument. For details on displaying and adjusting the image, refer to the documentation supplied with the ultrasound diagnostic instrument.

 <b>Caution</b>	
	Do not operate the probe with excessive force. Use with excessive force could result in injury to the patient.
	Scan for minimum time necessary at the lowest possible acoustic output. Acoustic output may affect the patient's internal tissues. For details about the acoustic output, please refer to the documentation supplied with the ultrasound diagnostic instrument.
	Do not touch the connector terminal pin of the probe. Electrostatic discharge may result in malfunction of the probe.
	Do not touch the probe connector of the ultrasound diagnostic instrument and the patient at the same time. It can cause electric shock to the patient.

4-2. How to attach/release the magnetic position sensor and the magnetic position sensor attachment

4-2-1. How to attach the magnetic position sensor

- (1) Align the direction mark of the magnetic position sensor and the hole of the magnetic position sensor attachment and place the sensor into the attachment as shown in Figure 3.

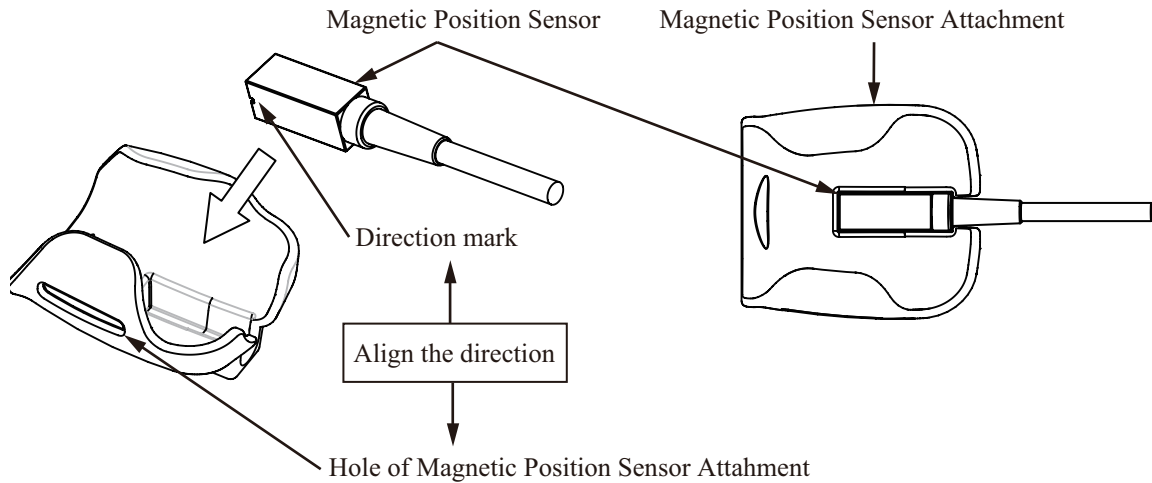

Figure 3 How to attach Magnetic Position Sensor

- (2) Attach the magnetic position sensor attachment to the probe by turning it anti-clockwise as shown in Figure 4. Please confirm that the hole of the attachment and the front mark of the probe are aligned in the same direction.

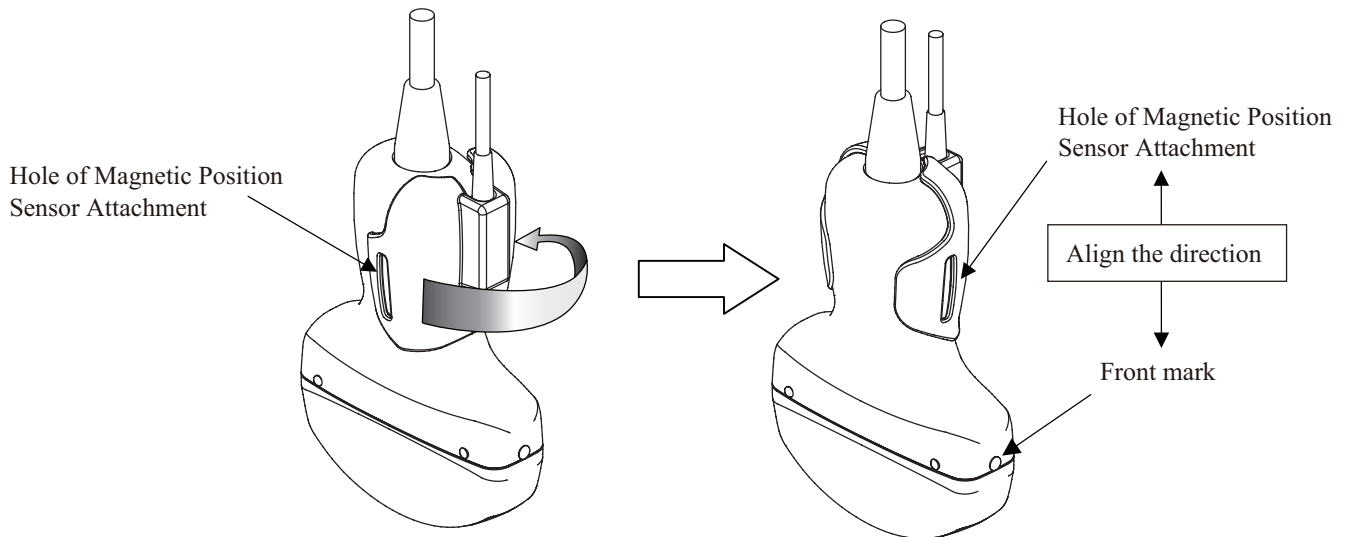

Figure 4 How to attach Magnetic Position Sensor Attachment

**⚠ Caution**

- ⚠ Attach the magnetic position sensor attachment to the probe correctly.
- ⚠ A false diagnosis may be caused if the attachment is attached in the wrong direction.

4-2-2. How to release the magnetic position sensor

- (1) Turn the magnetic position sensor attachment clockwise to release it from the probe as shown in Figure 5.

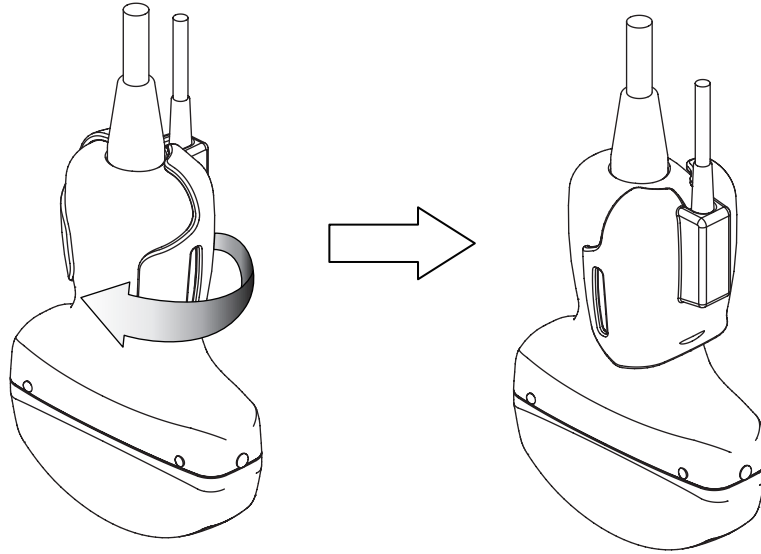

Figure 5 How to release Magnetic Position Sensor Attachment

- (2) Take out the magnetic position sensor from the magnetic position sensor attachment as shown in Figure 6.

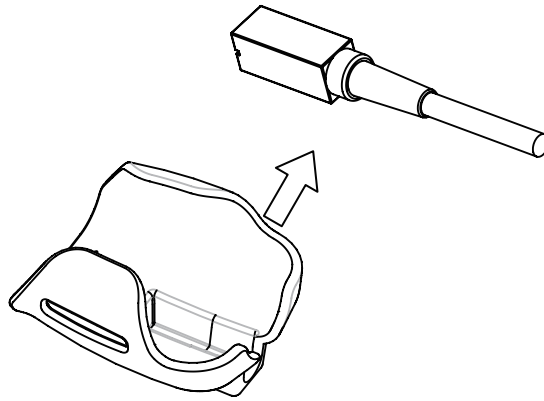

Figure 6 How to release Magnetic Position Sensor

This page intentionally left blank

This page intentionally left blank

■ Manufacturer

 Hitachi, Ltd.

2-16-1, Higashi-Ueno, Taito-ku, Tokyo, 110-0015, Japan

■ Contact

+81-3-6284-3668

<http://www.hitachi.com/businesses/healthcare/index.html>

Overseas Offices:



Hitachi Medical Systems GmbH  
Otto-von-Guericke-Ring 3 D-65205 Wiesbaden, Germany

EU Importer: Hitachi Medical Systems Europe Holding AG  
Address: Sumpfstrasse 13 CH-6300 Zug, Switzerland

US Importer: Hitachi Healthcare Americas Corporation  
Address: 1959 Summit Commerce Park, Twinsburg, Ohio 44087

Distributor